



## POD PHONE SMALL

POD PHONE SMALL is a telephone booth that improves privacy when taking phone calls in open spaces and office environments.

### TECHNICAL INFORMATION

AIR FLOW	Fully automated ventilation controlled by motion sensor. As standard, set to 1 hour and is adjustable up to 99 minutes. Air flow 22l/s.
LIGHTS	Fully automated lights controlled by motion sensor. As standard, set to 1 hour and is adjustable up to 99 minutes. LED light set on the ceiling. Lumen 871.
WHEELS	Installation wheels included.
ENERGY CONSUMPTION PER HOUR	Total 0,01895 kWh. Fans 0,00445 kWh. Lights 0,0145 kWh. Max load 8 A.
SOCKET	One power socket on the table.
POWER CONNECTION	From the ceiling or floor. The length of the power cord is 3 m.

### MEASUREMENTS

EXTERNAL DIMENSIONS	W1000 x D1200 x H2220 mm
INNER DIMENSIONS	W800 x D800 x H2040 mm
DOOR	8 x 21
PACKAGE DIMENSIONS	W800 x D2400 x H1500 mm
WEIGHT	400 kg 333 kg/m <sup>2</sup>

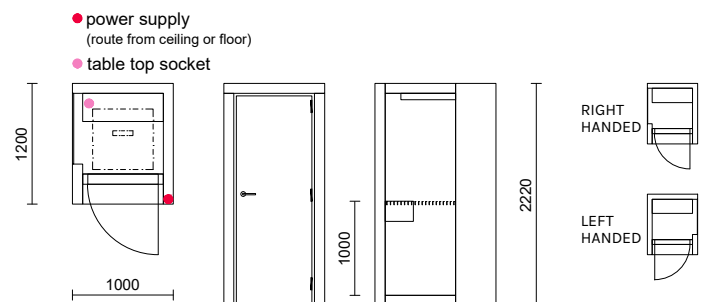

## MATERIAL DESCRIPTION

EXTERIOR	Melamine or veneered frame.
INTERIOR	Acoustic panel on the ceiling. Walls x 2 and floor coated with carpet.
DOOR	Painted MDF door. Melamine door side panels. Door handle with satin finished stainless steel.
WINDOW	Laminated acoustic safety glass window 10 mm. Glass window includes the INTO stripe window taping.
TABLE	MDF table with water-based paint.

## ADD-ON FEATURES

### POD PANEL

POD PANEL is an acoustic-friendly add-on piece for POD rooms. It can be used as a surface to attach notes, plans, and other sketches. Panels attaches easily to the POD exterior and softens the surrounding sound environment.



### OTHER AVAILABLE ADD-ON FEATURES

- Height adjustable stool
- Clothing hook
- Electronical lock system
- Booking system
- Smart glass
- Screen holder
- USB charger
- Extra power sockets
- AV systems (web camera, microphone)



All our materials comply with M1 emission classification.

**SURFACE FINISHES FOR POD ROOMS**

**STANDARD PRICE, CATEGORY 1**

Melamine color options

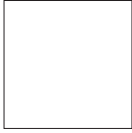

White



Dark grey

**PRICE CATEGORY 2**

Veneer options



Pine

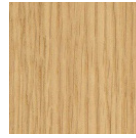

American oak



Black oak



**SURFACE FINISHES FOR DOOR & DOOR SIDE PANELS**

**STANDARD PRICE, CATEGORY 1**

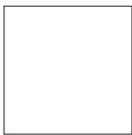

White

**PRICE CATEGORY 2**



American oak

**PRICE CATEGORY 3**



Clear glass 10 mm

comes with white door panels

**CARPETS FOR POD ROOMS: EX-DONO QUARTET FROM FLETCO | STANDARD PRICE, CATEGORY 1**

Composition: Polyester non woven  
 Static electrical propensity: Antistatic  
 Impact sound reduction: 25 dB  
 Classification for use: Commercial / heavy use  
 Fire resistant: Yes



393300    393340    393350

Ask for more colors: [sales@intoconcept.com](mailto:sales@intoconcept.com)

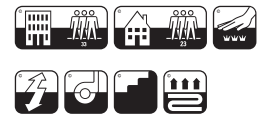

**CEILING ACOUSTIC PANEL FABRIC: SOUL FROM GABRIEL | STANDARD PRICE, CATEGORY 1**

Composition: 100% wool  
 Lightfastness: 5-7  
 Rubbing fastness: 4/wet, 4-5/dry  
 Sustainability: Complies with STANDARD 100 by OEKO-TEX  
 Meet Möbelfakta requirements  
 Cleaning: regular vacuum cleaning  
 Fire resistant: Yes (S 476 Part 7, class 1 ÖNORM B 3825-B1-3800-Q1 UK)

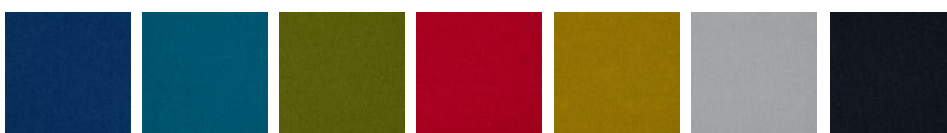

66104    67039    68131    64086    62059    61196    60182





## POD PHONE

POD PHONE is a phone booth that improves privacy when taking phone calls in open spaces and office environments.

### TECHNICAL INFORMATION

AIR FLOW	Fully automated ventilation controlled by motion sensor. As standard, set to 1 hour and is adjustable up to 99 minutes. Air flow 22l/s.
LIGHTS	Fully automated lights controlled by motion sensor. As standard, set to 1 hour and is adjustable up to 99 minutes. LED light set on the ceiling. Lumen 871.
WHEELS	Installation wheels included.
ENERGY CONSUMPTION PER HOUR	Total 0,01895 kWh. Fans 0,00445 kWh. Lights 0,0145 kWh. Max load 8 A.
SOCKET	One power socket on the table.
POWER CONNECTION	From the ceiling or floor. The length of the power cord is 3 m.

### MEASUREMENTS

EXTERNAL DIMENSIONS	W1000 x D1500 x H2220 mm
INNER DIMENSIONS	W800 x D1100 x H2040 mm
DOOR	8 x 21
PACKAGE DIMENSIONS	W800 x D2400 x H1500 mm
WEIGHT	460 kg 307 kg/m <sup>2</sup>

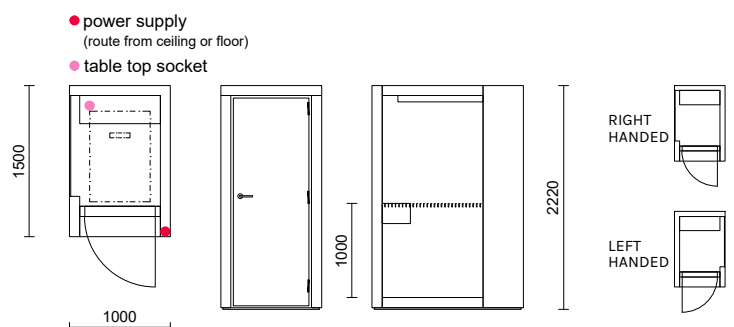

## MATERIAL DESCRIPTION

EXTERIOR	Melamine or veneered frame.
INTERIOR	Acoustic panel on the ceiling. Walls x 2 and floor coated with carpet.
DOOR	Painted MDF door. Melamine door side panels. Door handle with satin finished stainless steel.
WINDOW	Laminated acoustic safety glass window 10 mm. Glass window includes the INTO stripe window taping.
TABLE	MDF table with water-based paint.

## ADD-ON FEATURES

### POD PANEL

POD PANEL is an acoustic-friendly add-on piece for POD rooms. It can be used as a surface to attach notes, plans, and other sketches. Panels attaches easily to the POD exterior and softens the surrounding sound environment.



### OTHER AVAILABLE ADD-ON FEATURES

- Height adjustable stool
- Clothing hook
- Electronical lock system
- Booking system
- Smart glass
- Screen holder
- USB charger
- Extra power sockets
- AV systems (web camera, microphone)



All our materials comply with M1 emission classification.

**SURFACE FINISHES FOR POD ROOMS**

**STANDARD PRICE, CATEGORY 1**

Melamine color options

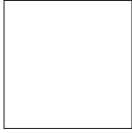

White



Dark grey

**PRICE CATEGORY 2**

Veneer options



Pine

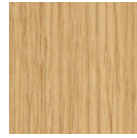

American oak



Black oak



**SURFACE FINISHES FOR DOOR & DOOR SIDE PANELS**

**STANDARD PRICE, CATEGORY 1**



White

**PRICE CATEGORY 2**

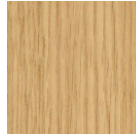

American oak

**PRICE CATEGORY 3**



Clear glass 10 mm

comes with white door panels

**CARPETS FOR POD ROOMS: EX-DONO QUARTET FROM FLETCO | STANDARD PRICE, CATEGORY 1**

Composition: Polyester non woven  
Static electrical propensity: Antistatic  
Impact sound reduction: 25 dB  
Classification for use: Commercial / heavy use  
Fire resistant: Yes



393300



393340



393350

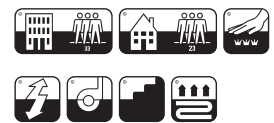
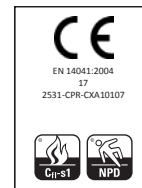

Ask for more colors: [sales@intoconcept.com](mailto:sales@intoconcept.com)

**CEILING ACOUSTIC PANEL FABRIC: SOUL FROM GABRIEL | STANDARD PRICE, CATEGORY 1**

Composition: 100% wool  
Lightfastness: 5-7  
Rubbing fastness: 4/wet, 4-5/dry  
Sustainability: Complies with STANDARD 100 by OEKO-TEX  
Meet Möbelfakta requirements  
Cleaning: regular vacuum cleaning  
Fire resistant: Yes (S 476 Part 7, class 1 ÖNORM B 3825-B1-3800-Q1 UK)



66104



67039



68131

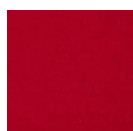

64086

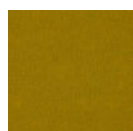

62059

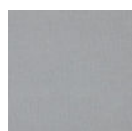

61196



60182





## POD 1

POD 1 is the number one choice for private phone calls and a workspace for tasks which demand focusing.

### TECHNICAL INFORMATION

AIR FLOW	Fully automated ventilation controlled by motion sensor. As standard, set to 1 hour and is adjustable up to 99 minutes. Switch for ventilation. Air flow 22 l/s.
LIGHTS	Fully automated lights controlled by motion sensor. As standard, set to 1 hour and is adjustable up to 99 minutes. Switch for lights. 2 x LED light set on the ceiling. A window lamp. Lumen 1742.
WHEELS	Installation wheels included.
ENERGY CONSUMPTION PER HOUR	Total 0,04045 kWh. Fans 0,00445 kWh. Lights 0,036 kWh. Max load 8 A.
SOCKET	3 x power sockets + 1 x data outlet included
POWER CONNECTION	From the ceiling or floor. The length of the power cord is 3 m.

### MEASUREMENTS

EXTERNAL DIMENSIONS	W1700 x D1700 x H2220 mm
DOOR	9 x 21
INNER DIMENSIONS	W1500 x D1300 x H2040 mm
PACKAGE DIMENSIONS	W1200 x D2400 x H1500 mm

WEIGHT  
690 kg  
239kg/m<sup>2</sup>

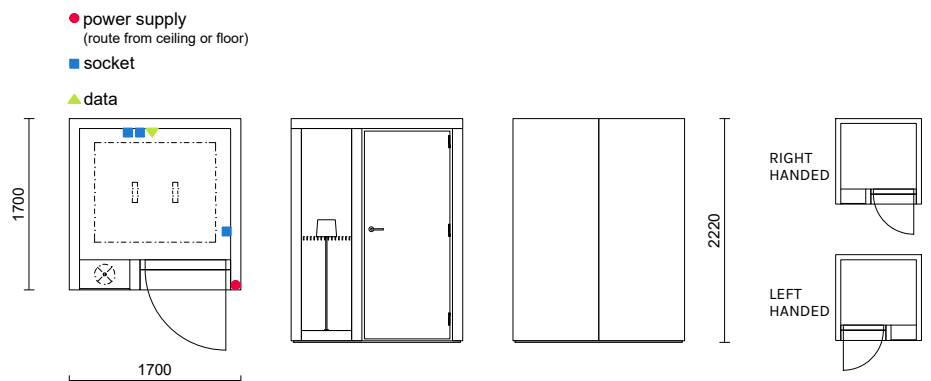

## MATERIAL DESCRIPTION

EXTERIOR	Melamine or veneered frame.
INTERIOR	Acoustic panel on the ceiling. Back wall and floor coated with carpet.
DOOR	Painted MDF door. Melamine door side panels. Door handle with satin finished stainless steel.
WINDOW	Laminated acoustic safety glass window 10 mm. Glass window includes the INTO stripe window taping.

## ADD-ON FEATURES

### POD PANEL

POD PANEL is an acoustic-friendly add-on piece for POD rooms. It can be used as a surface to attach notes, plans, and other sketches. Panels attaches easily to the POD exterior and softens the surrounding sound environment.

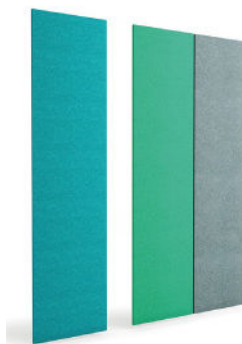

### ACCESSIBILITY SET

Wheelchair ramp.  
Reservation for automatic door.  
Automatic door closer.  
Hydraulic door closer.  
Kick-plates for the door and/or walls.  
Vertical and/or horizontal bar handles.



### FURNITURE SET

Furnish the POD room with INTO sofas and tables.  
For example: 2 x POINT 700, TOP LIFT HIGH 400 x 600.



### OTHER AVAILABLE ADD-ON FEATURES

Air cooling device  
Clothing hook  
Electronical lock system  
Booking system  
Smart glass  
USB charger  
Extra power sockets  
AV systems (web camera, microphone)





All our materials comply with M1 emission classification.

**SURFACE FINISHES FOR POD ROOMS**

**STANDARD PRICE, CATEGORY 1**

Melamine color options

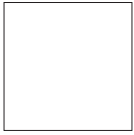

White



Dark grey

**PRICE CATEGORY 2**

Veneer options

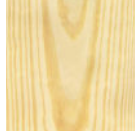

Pine

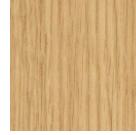

American oak



Black oak



**SURFACE FINISHES FOR DOOR & DOOR SIDE PANELS**

**STANDARD PRICE, CATEGORY 1**

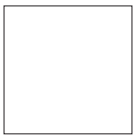

White

**PRICE CATEGORY 2**



American oak

**PRICE CATEGORY 3**



Clear glass 10 mm

comes with white door panels

**CARPETS FOR POD ROOMS: EX-DONO QUARTET FROM FLETCO | STANDARD PRICE, CATEGORY 1**

Composition: Polyester non woven  
Static electrical propensity: Antistatic  
Impact sound reduction: 25 dB  
Classification for use: Commercial / heavy use  
Fire resistant: Yes



393300    393340    393350

Ask for more colors: [sales@intoconcept.com](mailto:sales@intoconcept.com)

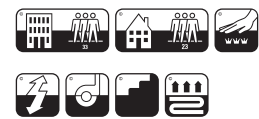

**CEILING ACOUSTIC PANEL FABRIC: SOUL FROM GABRIEL | STANDARD PRICE, CATEGORY 1**

Composition: 100% wool  
Lightfastness: 5-7  
Rubbing fastness: 4/wet, 4-5/dry  
Sustainability: Complies with STANDARD 100 by OEKO-TEX  
Meet Möbelfakta requirements  
Cleaning: regular vacuum cleaning  
Fire resistant: Yes (S 476 Part 7, class 1 ÖNORM B 3825-B1-3800-Q1 UK)

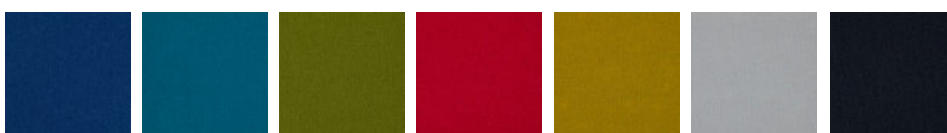

66104    67039    68131    64086    62059    61196    60182



## POD 2

The POD 2 small meeting room is ideal for 2-4 people for spontaneous but confidential meetings and as an adaptable workspace.



### TECHNICAL INFORMATION

AIR FLOW	Fully automated ventilation controlled by motion sensor. As standard, set to 1 hour and is adjustable up to 99 minutes. Switch for ventilation. Air flow 44 l/s.
LIGHTS	Fully automated lights controlled by motion sensor. As standard, set to 1 hour and is adjustable up to 99 minutes. Switch for lights. 2 x LED light set on the ceiling. A window lamp. Lumen 1742.
WHEELS	Installation wheels included.
ENERGY CONSUMPTION PER HOUR	Total 0,0449 kWh. Fans 0,0089 kWh. Lights 0,036 kWh. Max load 8 A.
SOCKET	3 x power sockets + 2 x data outlets included.
POWER CONNECTION	From the ceiling or floor. The length of the power cord is 3 m.

### MEASUREMENTS

EXTERNAL DIMENSIONS	W2500 x D1700 x H2220 mm
DOOR	9 x 21
INNER DIMENSIONS	W2300 x D1300 x H2040 mm
PACKAGE DIMENSIONS	W1200 x D2520x H1500 mm
WEIGHT	910 kg 214 kg/m <sup>2</sup>

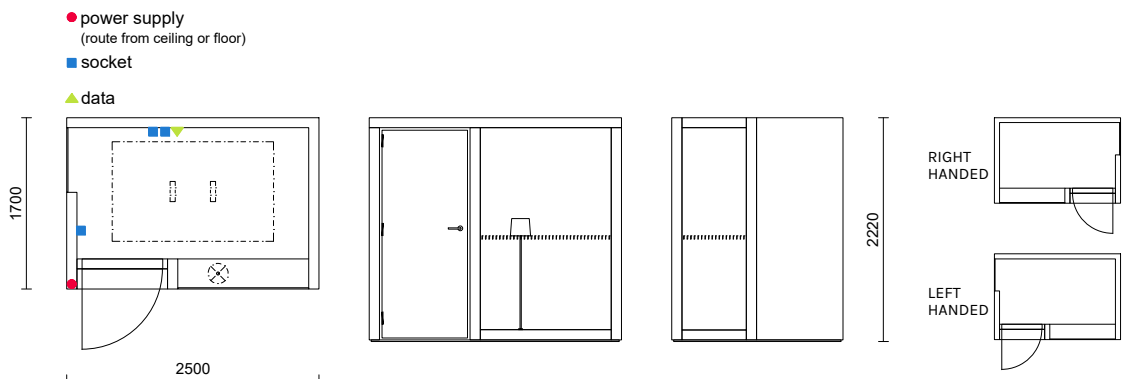

## MATERIAL DESCRIPTION

EXTERIOR	Melamine or veneered frame.
INTERIOR	Acoustic panel on the ceiling. Back wall and floor coated with carpet.
DOOR	Painted MDF door. Melamine door side panels. Door handle with satin finished stainless steel.
WINDOW	Laminated acoustic safety glass window 10 mm. Glass window includes the INTO stripe window taping.

## ADD-ON FEATURES

### POD PANEL

POD PANEL is an acoustic-friendly add-on piece for POD rooms. It can be used as a surface to attach notes, plans, and other sketches. Panels attaches easily to the POD exterior and softens the surrounding sound environment.



### FURNITURE SET

Furnish the POD room with INTO sofas and tables. For example: 1 x POINT 700, 2 x POINT 500, TOP LIFT HIGH 600 x 800.



### ACCESSIBILITY SET

Wheelchair ramp.  
Reservation for automatic door.  
Automatic door closer.  
Hydraulic door closer.  
Kick-plates for the door and/or walls.  
Vertical and/or horizontal bar handles.



### OTHER AVAILABLE ADD-ON FEATURES

Air cooling device  
Clothing hook  
Electronical lock system  
Booking system  
Smart glass  
USB charger  
Extra power sockets  
AV systems (web camera, microphone)  
Automatic fire extinguisher system



All our materials comply with M1 emission classification.

**SURFACE FINISHES FOR POD ROOMS**

**STANDARD PRICE, CATEGORY 1**

Melamine color options

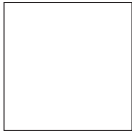

White



Dark grey

**PRICE CATEGORY 2**

Veneer options



Pine

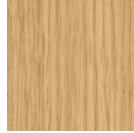

American oak

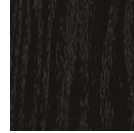

Black oak



**SURFACE FINISHES FOR DOOR & DOOR SIDE PANELS**

**STANDARD PRICE, CATEGORY 1**



White

**PRICE CATEGORY 2**

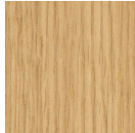

American oak

**PRICE CATEGORY 3**



Clear glass 10 mm

comes with white door panels

**CARPETS FOR POD ROOMS: EX-DONO QUARTET FROM FLETCO | STANDARD PRICE, CATEGORY 1**

Composition: Polyester non woven  
Static electrical propensity: Antistatic  
Impact sound reduction: 25 dB  
Classification for use: Commercial / heavy use  
Fire resistant: Yes



393300    393340    393350

Ask for more colors: [sales@intoconcept.com](mailto:sales@intoconcept.com)



**CEILING ACOUSTIC PANEL FABRIC: SOUL FROM GABRIEL | STANDARD PRICE, CATEGORY 1**

Composition: 100% wool  
Lightfastness: 5-7  
Rubbing fastness: 4/wet, 4-5/dry  
Sustainability: Complies with STANDARD 100 by OEKO-TEX  
Meet Möbelfakta requirements  
Cleaning: regular vacuum cleaning  
Fire resistant: Yes (S 476 Part 7, class 1 ÖNORM B 3825-B1-3800-Q1 UK)

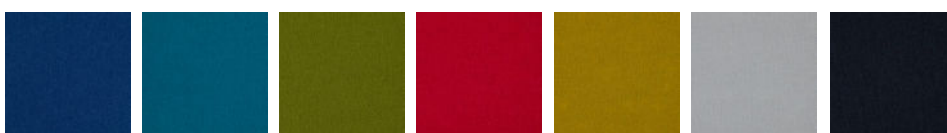

66104    67039    68131    64086    62059    61196    60182



## POD 3

POD 3 is a versatile workspace ideal for 1-3 people, offering a compact setting for focused work or easily transforming into a small meeting room for collaborative meetings.



### TECHNICAL INFORMATION

AIR FLOW	Fully automated ventilation controlled by motion sensor that is adjustable up to 99 minutes. Switch for ventilation. Airflow rate of 44 l/s when occupied.
LIGHTS	Fully automated lights controlled by motion sensor that is adjustable up to 99 minutes. Switch for lights. 4 x LED light set on the ceiling. A window lamp. Lumen 3484.
WHEELS	Installation wheels included.
ENERGY CONSUMPTION PER HOUR	Total capacity 73,9 W. Fans capacity 8,9 W. Lights capacity 65 W. Max load 8 A.
SOCKET	3 x power sockets + 2 x data outlets included.
POWER CONNECTION	From the ceiling or floor. The length of the power cord is 3 m.

### MEASUREMENTS

EXTERNAL DIMENSIONS	W1700 x D3400 x H2220 mm
DOOR	9 x 21
INNER DIMENSIONS	W1500 x D3000 x H2040 mm
PACKAGE DIMENSIONS	2 x pallet: W1200 x D2500 x H1400 mm and W1200 x D2500x H1400 mm
WEIGHT	1150 kg 198 kg/m <sup>2</sup>

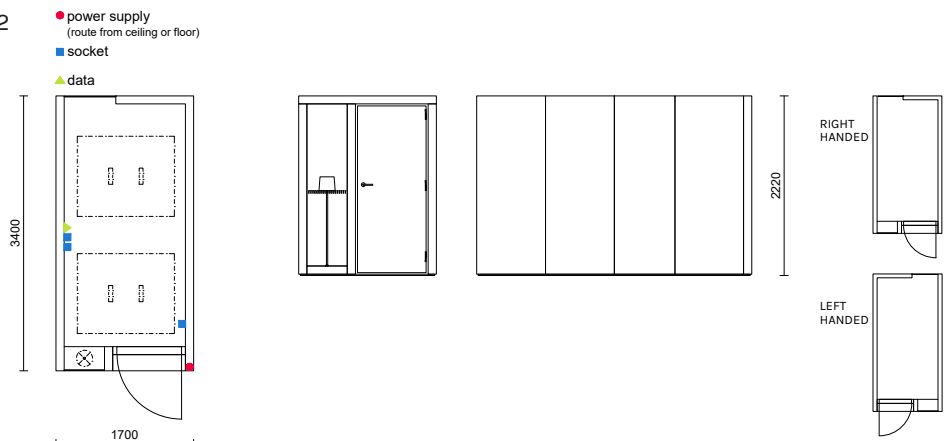

## MATERIAL DESCRIPTION

EXTERIOR	Melamine or veneered frame.
INTERIOR	Acoustic panel on the ceiling. One wall and floor coated with carpet.
DOOR	Painted MDF door. Melamine door side panels. Door handle with satin finished stainless steel.
WINDOW	Laminated acoustic safety glass window 10 mm. Glass window includes the INTO stripe window taping.

## ADD-ON FEATURES

### DISPLAY BOX

DISPLAY BOX is a screen stand for the POD meeting rooms that hides the cables and the remote control. Suitable for a maximum 42" screen.



### POD PANEL

POD PANEL is an acoustic-friendly add-on piece for POD rooms. It can be used as a surface to attach notes, plans, and other sketches. Panels attach easily to the POD exterior and softens the surrounding sound environment.



### ACCESSIBILITY SET

Wheelchair ramp.  
Reservation for automatic door.  
Automatic door closer.  
Hydraulic door closer.  
Kick-plates for the door and/or walls.  
Vertical and/or horizontal bar handles.



### FURNITURE SET

Furnish the POD room with INTO tables and height-adjustable stools.  
For example: 2 x TOP LIFT HIGH 1000 x 500 mm,  
2 x height adjustable balancing stool



### OTHER AVAILABLE ADD-ON FEATURES

- Air cooling device
- Clothing hook
- Electronical lock system
- Booking system
- Smart glass
- USB charger
- Extra power sockets
- AV systems (web camera, microphone)
- Automatic fire extinguisher system



All our materials comply with M1 emission classification.

**SURFACE FINISHES FOR POD ROOMS**

**STANDARD PRICE, CATEGORY 1**

Melamine color options

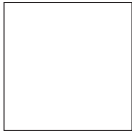

White



Dark grey

**PRICE CATEGORY 2**

Veneer options



Pine

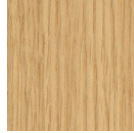

American oak

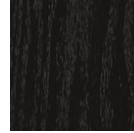

Black oak



**SURFACE FINISHES FOR DOOR & DOOR SIDE PANELS**

**STANDARD PRICE, CATEGORY 1**



White

**PRICE CATEGORY 2**

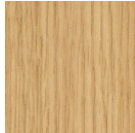

American oak

**PRICE CATEGORY 3**



Clear glass 10 mm

comes with white door panels

**CARPETS FOR POD ROOMS: EX-DONO QUARTET FROM FLETCO | STANDARD PRICE, CATEGORY 1**

Composition: Polyester non woven  
Static electrical propensity: Antistatic  
Impact sound reduction: 25 dB  
Classification for use: Commercial / heavy use  
Fire resistant: Yes



393300    393340    393350

Ask for more colors: [sales@intoconcept.com](mailto:sales@intoconcept.com)



**CEILING ACOUSTIC PANEL FABRIC: SOUL FROM GABRIEL | STANDARD PRICE, CATEGORY 1**

Composition: 100% wool  
Lightfastness: 5-7  
Rubbing fastness: 4/wet, 4-5/dry  
Sustainability: Complies with STANDARD 100 by OEKO-TEX  
Meet Möbelfakta requirements  
Cleaning: regular vacuum cleaning  
Fire resistant: Yes (S 476 Part 7, class 1 ÖNORM B 3825-B1-3800-Q1 UK)

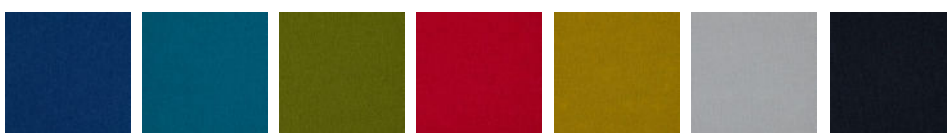

66104    67039    68131    64086    62059    61196    60182





## POD 4

POD 4 meeting rooms are suitable for 4-8 people and perfect for private or confidential meetings as well as adaptable work spaces.

### TECHNICAL INFORMATION

<b>AIR FLOW</b>	Fully automated ventilation controlled by motion sensor. As standard, set to 1 hour and is adjustable up to 99 minutes. Switch for ventilation. Air flow 88l/s.
<b>LIGHTS</b>	Fully automated lights controlled by motion sensor. As standard, set to 1 hour and is adjustable up to 99 minutes. Switch for lights. 4 x LED light set on the ceiling. 1 window lamp. Lumen 3484.
<b>WHEELS</b>	Installation wheels included.
<b>ENERGY CONSUMPTION PER HOUR</b>	Total 0,0828 kWh. Fans 0,0178 kWh. Lights 0,065 kWh. Max load 8 A.
<b>SOCKET</b>	4 x power sockets + 2 x data outlets included.
<b>POWER CONNECTION</b>	From the ceiling or floor. The length of the power cord is 3 m.

### MEASUREMENTS

<b>EXTERNAL DIMENSIONS</b>	W3400 x D2500 x H2220 mm
<b>DOOR</b>	9 x 21
<b>INNER DIMENSIONS</b>	W3200 x D2100 x H2040 mm
<b>PACKAGE DIMENSIONS</b>	2 x pallet: W1200 x L2520 x H1500 and W1200 x L2400 x H1500
<b>WEIGHT</b>	1450 kg 171 kg/m <sup>2</sup>

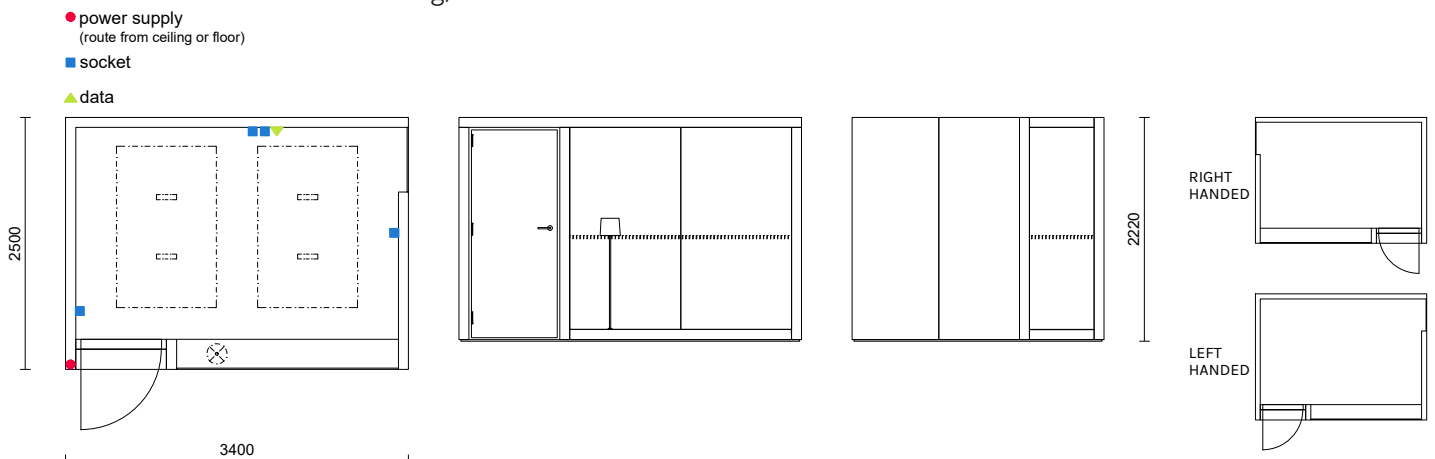



## MATERIAL DESCRIPTION

EXTERIOR	Melamine or veneered frame.
INTERIOR	Acoustic panels on the ceiling. Back wall and floor coated with carpet.
DOOR	Painted MDF door. Melamine door side panels. Door handle with satin finished stainless steel.
WINDOW	Laminated acoustic safety glass window 10 mm. Glass window includes the INTO stripe window taping.

## ADD-ON FEATURES

### DISPLAY BOX

DISPLAY BOX is a screen stand for the POD meeting rooms that hides the cables and the remote control. Suitable for a maximum 42" screen.



### POD PANEL

POD PANEL is an acoustic-friendly add-on piece for POD rooms. It can be used as a surface to attach notes, plans, and other sketches. Panels attaches easily to the POD exterior and softens the surrounding sound environment.

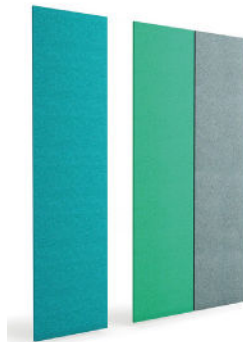

### ACCESSIBILITY SET

Wheelchair ramp.  
Reservation for automatic door.  
Automatic door closer.  
Hydraulic door closer.  
Kick-plates for the door and/or walls.  
Vertical and/or horizontal bar handles.



### FURNITURE SET

Furnish the POD room with INTO sofas and tables.  
For example; 4 x POINT 700, 1 x POINT CORNER,  
2 x TOP CURVE, 1 x DISPLAY BOX



### OTHER ADD-ON FEATURES

Air cooling device  
Clothing hook  
Electronical lock system  
Booking system  
Smart glass  
USB charger  
Extra power sockets  
AV systems (web camera, microphone)  
Automatic fire extinguisher system



All our materials comply with M1 emission classification.

**SURFACE FINISHES FOR POD ROOMS**

**STANDARD PRICE, CATEGORY 1**

Melamine color options

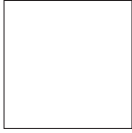

White



Dark grey

**PRICE CATEGORY 2**

Veneer options

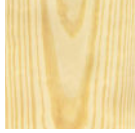

Pine

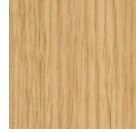

American oak

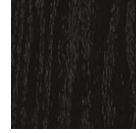

Black oak



**SURFACE FINISHES FOR DOOR & DOOR SIDE PANELS**

**STANDARD PRICE, CATEGORY 1**

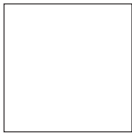

White

**PRICE CATEGORY 2**



American oak

**PRICE CATEGORY 3**



Clear glass 10 mm

comes with white door panels

**CARPETS FOR POD ROOMS: EX-DONO QUARTET FROM FLETCO | STANDARD PRICE, CATEGORY 1**

Composition: Polyester non woven  
 Static electrical propensity: Antistatic  
 Impact sound reduction: 25 dB  
 Classification for use: Commercial / heavy use  
 Fire resistant: Yes



393300    393340    393350

Ask for more colors: [sales@intoconcept.com](mailto:sales@intoconcept.com)

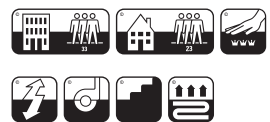
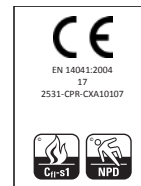

**CEILING ACOUSTIC PANEL FABRIC: SOUL FROM GABRIEL | STANDARD PRICE, CATEGORY 1**

Composition: 100% wool  
 Lightfastness: 5-7  
 Rubbing fastness: 4/wet, 4-5/dry  
 Sustainability: Complies with STANDARD 100 by OEKO-TEX  
 Meet Möbelfakta requirements  
 Cleaning: regular vacuum cleaning  
 Fire resistant: Yes (S 476 Part 7, class 1 ÖNORM B 3825-B1-3800-Q1 UK)

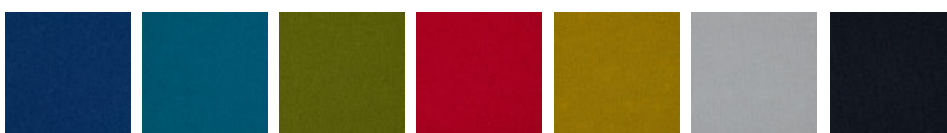

66104    67039    68131    64086    62059    61196    60182





## POD MAX

POD MAX is a meeting room designed for 8-10 people, providing a comfortable space for bigger group meetings.

### TECHNICAL INFORMATION

AIR FLOW	Fully automated ventilation controlled by motion sensor that is adjustable up to 99 minutes. Switch for ventilation. Airflow rate of 88 l/s when occupied.
LIGHTS	Fully automated lights controlled by motion sensor that is adjustable up to 99 minutes. Switch for lights. 8 x LED light set on the ceiling. 1 window lamp. Lumen 6968.
WHEELS	Installation wheels included.
ENERGY CONSUMPTION PER HOUR	Total capacity 141 W. Fans capacity 17,8 W. Lights capacity 123 W. Max load 8 A.
SOCKET	6 x power sockets + 4 x data outlets included.
POWER CONNECTION	From the ceiling or floor. The length of the power cord is 3 m.

### MEASUREMENTS

EXTERNAL DIMENSIONS	W3400 x D5000 x H2220 mm
DOOR	9 x 21
INNER DIMENSIONS	W3000 x D4800 x H2040 mm
PACKAGE DIMENSIONS	2 x pallet: W1200 x D2500 x H1400 and W1200 x D2500 x H1400
WEIGHT	2500 kg 147 kg/m <sup>2</sup>

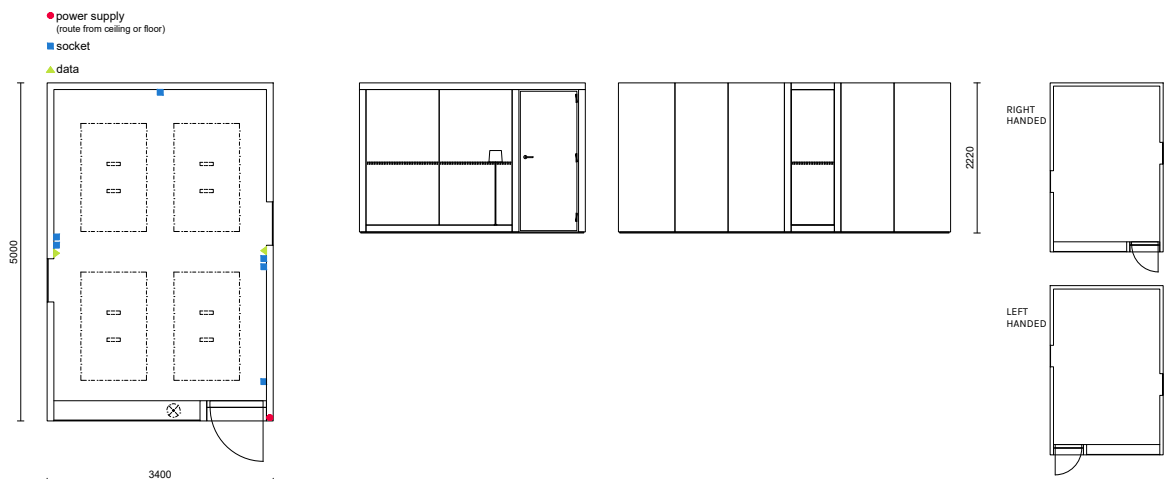

## MATERIAL DESCRIPTION

EXTERIOR	Melamine or veneered frame.
INTERIOR	Acoustic panels on the ceiling. Back wall and floor coated with carpet.
DOOR	Painted MDF door. Melamine door side panels. Door handle with satin finished stainless steel.
WINDOW	Laminated acoustic safety glass window 10 mm. Glass window includes the INTO stripe window taping.

## ADD-ON FEATURES

### DISPLAY BOX

DISPLAY BOX is a screen stand for the POD meeting rooms that hides the cables and the remote control. Suitable for a maximum 42" screen.



### POD PANEL

POD PANEL is an acoustic-friendly add-on piece for POD rooms. It can be used as a surface to attach notes, plans, and other sketches. Panels attaches easily to the POD exterior and softens the surrounding sound environment.



## ACCESSIBILITY SET

Wheelchair ramp.  
Reservation for automatic door.  
Automatic door closer.  
Hydraulic door closer.  
Kick-plates for the door and/or walls.  
Vertical and/or horizontal bar handles.



## FURNITURE SET

Furnish the POD room with 2 x conference tables and 8 x conference chairs.



## OTHER ADD-ON FEATURES

Air cooling device  
Clothing hook  
Electronical lock system  
Booking system  
Smart glass  
USB charger  
Extra power sockets  
AV systems (web camera, microphone)  
Automatic fire extinguisher system



All our materials comply with M1 emission classification.

**SURFACE FINISHES FOR POD ROOMS**

**STANDARD PRICE, CATEGORY 1**

Melamine color options

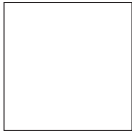

White



Dark grey

**PRICE CATEGORY 2**

Veneer options



Pine

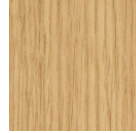

American oak



Black oak



**SURFACE FINISHES FOR DOOR & DOOR SIDE PANELS**

**STANDARD PRICE, CATEGORY 1**



White

**PRICE CATEGORY 2**

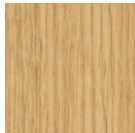

American oak

**PRICE CATEGORY 3**



Clear glass 10 mm

comes with white door panels

**CARPETS FOR POD ROOMS: EX-DONO QUARTET FROM FLETCO | STANDARD PRICE, CATEGORY 1**

Composition: Polyester non woven  
 Static electrical propensity: Antistatic  
 Impact sound reduction: 25 dB  
 Classification for use: Commercial / heavy use  
 Fire resistant: Yes



393300    393340    393350

Ask for more colors: [sales@intoconcept.com](mailto:sales@intoconcept.com)

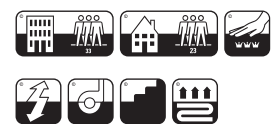
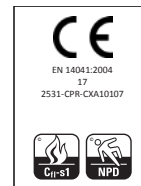

**CEILING ACOUSTIC PANEL FABRIC: SOUL FROM GABRIEL | STANDARD PRICE, CATEGORY 1**

Composition: 100% wool  
 Lightfastness: 5-7  
 Rubbing fastness: 4/wet, 4-5/dry  
 Sustainability: Complies with STANDARD 100 by OEKO-TEX  
 Meet Möbelfakta requirements  
 Cleaning: regular vacuum cleaning  
 Fire resistant: Yes (S 476 Part 7, class 1 ÖNORM B 3825-B1-3800-Q1 UK)



66104    67039    68131    64086    62059    61196    60182





## POD ROLL

POD ROLL is a compact solution for spontaneous meetings and independent work.

### TECHNICAL INFORMATION

Solution includes POINT sofas, table, ceiling lamp, power sockets, screen holder and wheels.

LIGHTS	Fully automated lights with electronic motion sensor. Switch for lights. Ceiling light. Lumen 2100.
WHEELS	Wheels under the POD ROLL makes it easy to turn and move around if needed.
ENERGY CONSUMPTION PER HOUR	Total 0,014 kWh. Lights 0,014 kWh. Max load 8 A.
SOCKET	One power socket on the tabletop + 3 under the table.
POWER CONNECTION	From the ceiling or floor. The length of the power cord is 3 m.

### MEASUREMENTS

EXTERNAL DIMENSIONS	W2300 x D1700 x H2230 mm
INNER DIMENSIONS	W2000 x D1670 x H1980 mm
TABLE	W700 x D1300 x H730 mm
PACKAGE DIMENSIONS	2 x pallet: W1000 x D2500 x H1500 mm and W850 x D1700 x H2000 mm
WEIGHT	700 kg 179 kg/m <sup>2</sup>

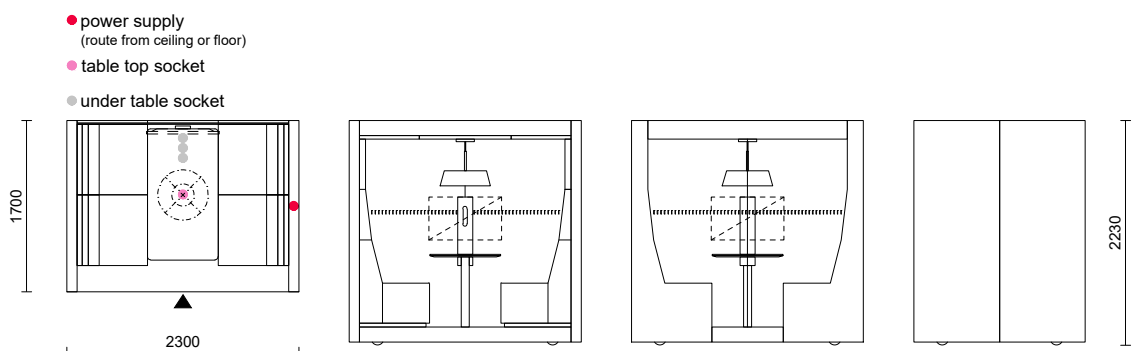



All our materials comply with M1 emission classification.

**MATERIAL DESCRIPTION**

EXTERIOR	Melamine frame.
INTERIOR	Floor coated with carpet. Ceiling and wall covered with upholstered acoustic panels.
TABLE	MDF table with structural painted top and powder coated steel base.
WINDOW	Laminated acoustic safety glass window 10 mm. Glass window includes the INTO stripe window taping.

**SURFACE FINISHES FOR POD ROLL | STANDARD PRICE, CATEGORY 1**

Melamine color options

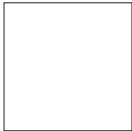

White



Dark grey



**CARPETS FOR POD ROOMS: EX-DONO QUARTET FROM FLETCO | STANDARD PRICE, CATEGORY 1**

Composition: Polyester non woven  
Static electrical propensity: Antistatic  
Impact sound reduction: 25 dB  
Classification for use: Commercial / heavy use  
Fire resistant: Yes



393300



393340



393350

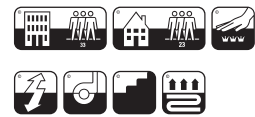

**COLOR OPTIONS FOR POD ROLL TABLE | STANDARD PRICE, CATEGORY 1**

TABLE TOP



NCS S 0500-N  
Structural

STEEL TUBE BASE

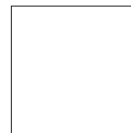

RAL 9016  
white

Ask for more colors: [sales@intoconcept.com](mailto:sales@intoconcept.com)

**SOFA FABRIC FOR POD ROLL: WOOLY FROM NEVOTEX | STANDARD PRICE, CATEGORY 1**

Composition: 70% Recycled wool, 25% Polyamide, 5% Other fibers  
 Durability: 150 000 Martindale  
 Lightfastness: 6  
 Crocking: 4-5/wet, 5/dry  
 Sustainability: certified according to Global Recycled Standard (GRS), no. CU1049784GRS-2023-00050154  
 Cleaning: vacuuming and dry cleaning  
 Fire resistant: Yes



2256 Ivory melange 2301 Marsala 1011 Bottle Green 228881 Lapis 1000 Light grey 2279 Ocean 1001 Anthracite



**SOFA FABRIC FOR POD ROLL: MAIN LINE FLAX FROM CAMIRA | STANDARD PRICE, CATEGORY 1**

Composition: 70% Virgin wool, 30% Flax  
 Durability: 50.000 Martindale  
 Light fastness: 5  
 Crocking: 3/wet, 4/dry  
 Sustainability: Complies with EU ecolabel "The Flower", Compostable  
 Cleaning: Vacuuming and dry cleaning  
 Fire resistant: Yes

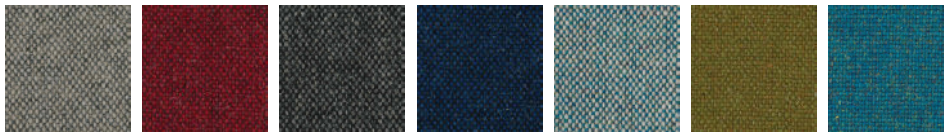

MLF02 MLF14 MLF16 MLF19 MLF24 MLF67 MLF37



**SOFA FABRIC FOR POD ROLL: PYTON FROM DELFOS FR | PRICE CATEGORY 2**

Synthetic leather  
 Composition: 77% PVC, 23% CO  
 Abrasion / Martindale: dry = 51.200 /cycles, wet = 12.800 /cycles  
 Light fastness: 5  
 Crocking: 4-5  
 Breathable  
 Fire resistant: Yes / Flame retardant, IMO Certificate

*Cleaning:*  
 Because of its characteristics, clean and care the material frequently, with lukewarm water and a damp cloth, preferably of micro fibre. Soiling may be treated with a mild soap and proceed next to its drying by using a hairdryer or, failing that, a drycloth. It should be avoided that areas that have been treated for cleaning remain wet



0796 Negro 1112 Smoke 0793 Mocca 1168 Cashmere



**SOFA FABRIC FOR POD ROLL: GRAIN/2288 FROM GABRIEL | PRICE CATEGORY 2**

Composition: 80% post-consumer recycled polyester / 20% polyester  
 Durability: 100.000 Martindale  
 Pilling: 5  
 Light fastness: 5-7  
 Cleaning: wash or dry cleaning  
 Fire resistant: Yes



61247 62123 64251 66233 68258 60323







## POD ROLL GLASS

POD ROLL GLASS is perfect for ad hoc meetings, work that needs focusing and works as a space divider and added seating space.

### TECHNICAL INFORMATION

Solution includes POINT sofas, table, ceiling lamp, power sockets, screen holder and wheels.

AIR FLOW	Fully automated ventilation with electronic motion sensor. Switch for ventilation. Air flow 44l/s.
LIGHTS	Fully automated lights with electronic motion sensor. Switch for lights. Ceiling light. Lumen 2100.
WHEELS	Wheels under the POD ROLL makes it easy to turn and move around if needed.
ENERGY CONSUMPTION PER HOUR	Total 0,0229 kWh. Fans 0,089 kWh. Lights 0,014 kWh. Max load 8 A.
SOCKET	One power socket on the tabletop + 3 under the table.
POWER CONNECTION	From the ceiling or floor. The length of the power cord is 3 m.

### MEASUREMENTS

EXTERNAL DIMENSIONS	W2300 x D1700 x H2230 mm
INNER DIMENSIONS	W2000 x D1670 x H1980 mm
TABLE	W700 x D1170 x H730 mm
PACKAGE DIMENSIONS	2 x pallet: W1200 x D2500 x H1500 mm and W850 x D1700 x H2000 mm
WEIGHT	800 kg 205 kg/m <sup>2</sup>

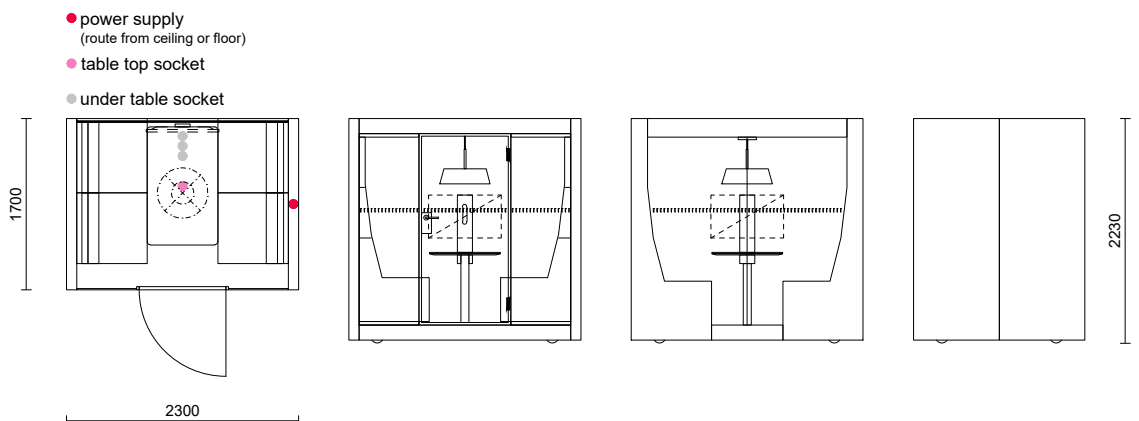



All our materials comply with M1 emission classification.

**MATERIAL DESCRIPTION**

EXTERIOR	Melamine frame.
INTERIOR	Floor coated with carpet. Ceiling and wall covered with upholstered acoustic panels.
TABLE	MDF table with structural painted top and powder coated steel base.
WINDOW	Laminated acoustic safety glass window 10 mm. Glass window includes the INTO stripe window taping.
DOOR	Clear glass 10 mm. Door handle with satin finished stainless steel.

**SURFACE FINISHES FOR POD ROLL GLASS | STANDARD PRICE, CATEGORY 1**

Melamine color options



White



Dark grey



**CARPETS FOR POD ROOMS: EX-DONO QUARTET FROM FLETCO | STANDARD PRICE, CATEGORY 1**

Composition: Polyester non woven  
Static electrical propensity: Antistatic  
Impact sound reduction: 25 dB  
Classification for use: Commercial / heavy use  
Fire resistant: Yes



393300



393340

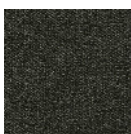

393350

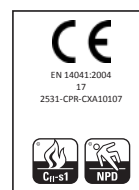

**COLOR OPTIONS FOR POD ROLL GLASS TABLE | STANDARD PRICE, CATEGORY 1**

TABLE TOP

STEEL TUBE BASE

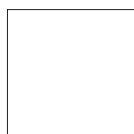

NCS S 0500-N  
Structural



RAL 9016  
white

Ask for more colors: [sales@intoconcept.com](mailto:sales@intoconcept.com)

**SOFA FABRIC FOR POD ROLL GLASS: WOOLY FROM NEVOTEX | STANDARD PRICE, CATEGORY 1**

Composition: 70% Recycled wool, 25% Polyamide, 5% Other fibers  
 Durability: 150 000 Martindale  
 Lightfastness: 6  
 Crocking: 4-5/wet, 5/dry  
 Sustainability: certified according to Global Recycled Standard (GRS), no. CU1049784GRS-2023-00050154  
 Cleaning: vacuuming and dry cleaning  
 Fire resistant: Yes



2256 Ivory melange    2301 Marsala    1011 Bottle Green    228881 Lapis    1000 Light grey    2279 Ocean    1001 Anthracite



**SOFA FABRIC FOR POD ROLL GLASS: MAIN LINE FLAX FROM CAMIRA | STANDARD PRICE, CATEGORY 1**

Composition: 70% Virgin wool, 30% Flax  
 Durability: 50.000 Martindale  
 Lightfastness: 5  
 Crocking: 3/wet, 4/dry  
 Sustainability: Complies with EU ecolabel "The Flower", Compostable  
 Cleaning: Vacuuming and dry cleaning  
 Fire resistant: Yes



MLF02    MLF14    MLF16    MLF19    MLF24    MLF67    MLF37



**SOFA FABRIC FOR POD ROLL GLASS: PYTON FROM DELFOS FR | PRICE CATEGORY 2**

Synthetic leather  
 Composition: 77% PVC, 23% CO  
 Abrasion / Martindale: dry = 51.200 /cycles, wet = 12.800 /cycles  
 Lightfastness: 5  
 Crocking: 4-5  
 Breathable  
 Fire resistant: Yes / Flame retardant, IMO Certificate

*Cleaning:*  
 Because of its characteristics, clean and care the material frequently, with lukewarm water and a damp cloth, preferably of micro fibre. Soiling may be treated with a mild soap and proceed next to its drying by using a hairdryer or, failing that, a drycloth. It should be avoided that areas that have been treated for cleaning remain wet



0796 Negro    1112 Smoke    0793 Mocca    1168 Cashmere



**SOFA FABRIC FOR POD ROLL GLASS: GRAIN/2288 FROM GABRIEL | PRICE CATEGORY 2**

Composition: 80% post-consumer recycled polyester / 20% polyester  
 Durability: 100.000 Martindale  
 Pilling: 5  
 Light fastness: 5-7  
 Cleaning: wash or dry cleaning  
 Fire resistant: Yes



61247    62123    64251    66233    68258    60323





## POD ROLL GLASS SMALL

POD ROLL GLASS SMALL is a quiet meeting pod for two people, ideal for spontaneous meetings. It is a timeless and easily movable solution for focused conversations.

### TECHNICAL INFORMATION

Solution includes POINT sofas, table, ceiling lamp, power sockets, screen holder and wheels.

AIR FLOW	Fully automated ventilation with electronic motion sensor. Switch for ventilation. Air flow 44l/s.
LIGHTS	Fully automated lights with electronic motion sensor. Switch for lights. Ceiling light. Lumen 2100.
WHEELS	Wheels under the POD ROLL GLASS SMALL makes it easy to turn and move around if needed.
ENERGY CONSUMPTION PER HOUR	Total 0,0229 kWh. Fans 0,089 kWh. Lights 0,014 kWh. Max load 8 A.
SOCKET	Two power socket on the tabletop.
POWER CONNECTION	From the ceiling or floor. The length of the power cord is 3 m.

### MEASUREMENTS

EXTERNAL DIMENSIONS	W2300 x D1200 x H2230 mm
INNER DIMENSIONS	W2000 x D1170 x H1980 mm
TABLE	W700 x D650 x H730 mm
PACKAGE DIMENSIONS	2 x pallet: W800 x L2300 x H1400 mm and W800 x L1500 x H1000 mm
WEIGHT	580 kg

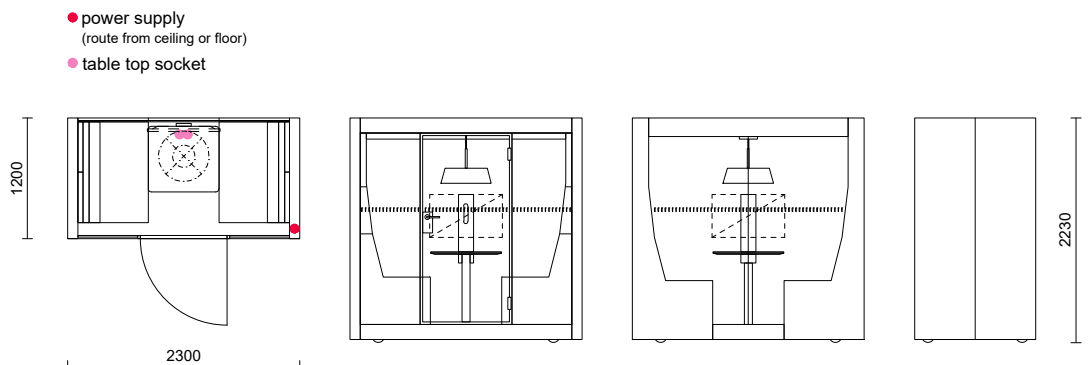



All our materials comply with M1 emission classification.

**MATERIAL DESCRIPTION**

EXTERIOR	Melamine frame.
INTERIOR	Floor coated with carpet. Ceiling and wall covered with upholstered acoustic panels.
TABLE	MDF table with structural painted top and powder coated steel base.
WINDOW	Laminated acoustic safety glass window 10 mm. Glass window includes the INTO stripe window taping.
DOOR	Clear glass 10 mm. Door handle with satin finished stainless steel.

**SURFACE FINISHES FOR POD ROLL GLASS SMALL | STANDARD PRICE, CATEGORY 1**

Melamine color options

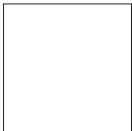

White



Dark grey



**CARPETS FOR POD ROOMS: EX-DONO QUARTET FROM FLETCO | STANDARD PRICE, CATEGORY 1**

Composition: Polyester non woven  
Static electrical propensity: Antistatic  
Impact sound reduction: 25 dB  
Classification for use: Commercial / heavy use  
Fire resistant: Yes



393300



393340

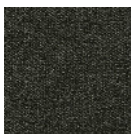

393350

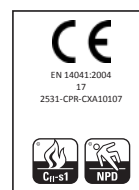

**COLOR OPTIONS FOR POD ROLL GLASS SMALL TABLE | STANDARD PRICE, CATEGORY 1**

TABLE TOP

STEEL TUBE BASE

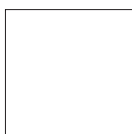

NCS S 0500-N  
Structural

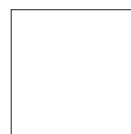

RAL 9016  
white

Ask for more colors: [sales@intoconcept.com](mailto:sales@intoconcept.com)

**SOFA FABRIC FOR POD ROLL GLASS SMALL: WOOLY FROM NEVOTEX | STANDARD PRICE, CATEGORY 1**

Composition: 70% Recycled wool, 25% Polyamide, 5% Other fibers  
 Durability: 150 000 Martindale  
 Lightfastness: 6  
 Crocking: 4-5/wet, 5/dry  
 Sustainability: certified according to Global Recycled Standard (GRS), no. CU1049784GRS-2023-00050154  
 Cleaning: vacuuming and dry cleaning  
 Fire resistant: Yes

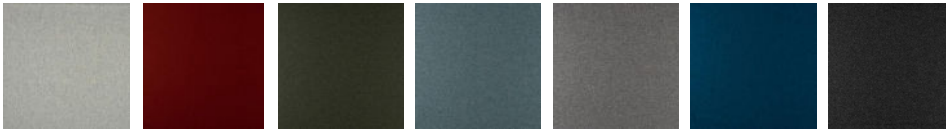

2256 Ivory melange    2301 Marsala    1011 Bottle Green    228881 Lapis    1000 Light grey    2279 Ocean    1001 Anthracite



**SOFA FABRIC FOR POD ROLL GLASS SMALL: MAIN LINE FLAX FROM CAMIRA | STANDARD PRICE, CATEGORY 1**

Composition: 70% Virgin wool, 30% Flax  
 Durability: 50.000 Martindale  
 Lightfastness: 5  
 Crocking: 3/wet, 4/dry  
 Sustainability: Complies with EU ecolabel "The Flower", Compostable  
 Cleaning: Vacuuming and dry cleaning  
 Fire resistant: Yes

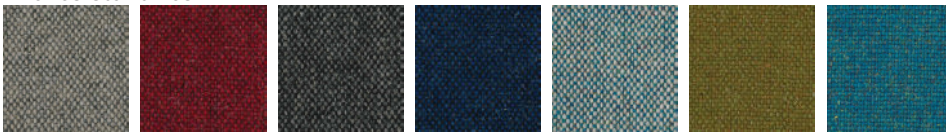

MLF02    MLF14    MLF16    MLF19    MLF24    MLF67    MLF37



**SOFA FABRIC FOR POD ROLL GLASS SMALL: PYTON FROM DELFOS FR | PRICE CATEGORY 2**

Synthetic leather  
 Composition: 77% PVC, 23% CO  
 Abrasion / Martindale: dry = 51.200 /cycles, wet = 12.800 /cycles  
 Lightfastness: 5  
 Crocking: 4-5  
 Breathable  
 Fire resistant: Yes / Flame retardant, IMO Certificate

*Cleaning:*  
 Because of its characteristics, clean and care the material frequently, with lukewarm water and a damp cloth, preferably of micro fibre. Soiling may be treated with a mild soap and proceed next to its drying by using a hairdryer or, failing that, a drycloth. It should be avoided that areas that have been treated for cleaning remain wet



0796 Negro    1112 Smoke    0793 Mocca    1168 Cashmere



**SOFA FABRIC FOR POD ROLL GLASS SMALL: GRAIN/2288 FROM GABRIEL | PRICE CATEGORY 2**

Composition: 80% post-consumer recycled polyester / 20% polyester  
 Durability: 100.000 Martindale  
 Pilling: 5  
 Light fastness: 5-7  
 Cleaning: wash or dry cleaning  
 Fire resistant: Yes

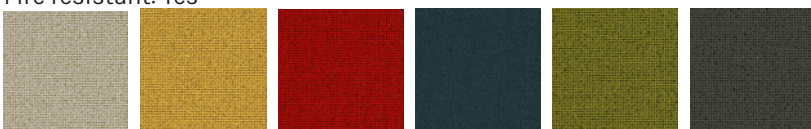

61247    62123    64251    66233    68258    60323





## POD PANEL

POD Panel is an acoustic-friendly add-on piece for POD rooms. The panels are easy to attach and detach with their effortless fastening system. They can also be used as a surfaces to attach notes, plans, and other sketches important for your team and their tasks.

<b>TECHNICAL INFORMATION</b>	Easy to attach and detach with effortless fastening system.
<b>MATERIAL DESCRIPTION</b>	Plywood frame with acoustic wool. Fully upholstered.
<b>MEASUREMENTS</b>	W500/600 x D45 x H2220 mm

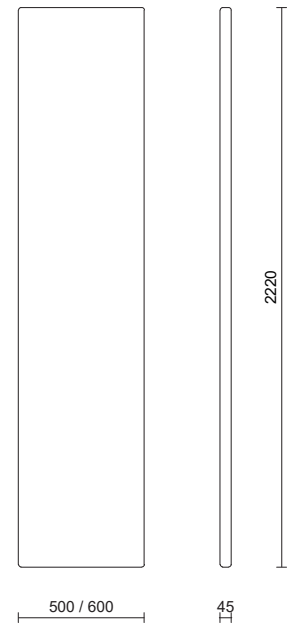

### ACOUSTIC PANEL FABRIC: SOUL FROM GABRIEL | STANDARD PRICE, CATEGORY 1

Composition: 100% wool  
 Lightfastness: 5-7  
 Rubbing fastness: 4/wet, 4-5/dry  
 Sustainability: Complies with STANDARD 100 by OEKO-TEX  
 Meet Möbelfakta requirements  
 Cleaning: regular vacuum cleaning  
 Fire resistant: Yes (S 476 Part 7, class 1 ÖNORM B 3825-B1-3800-Q1 UK)



All our materials comply with M1 emission classification.



66104    67039    68131    64086    62059    61196    60182



## WHEELCHAIR RAMP

In accordance with accessibility standards, a wheelchair ramp can be installed into the POD rooms, as well as reservation for the automatic door.



<b>TECHNICAL INFORMATION</b>	Available for POD rooms 1-4.
<b>MATERIAL DESCRIPTION</b>	Powder-coated steel with grip tape.
<b>MEASUREMENTS</b>	According to the door width.

### STANDARD COLOR FOR WHEELCHAIR RAMP

STANDARD PRICE, CATEGORY 1

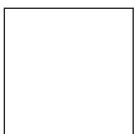

RAL 9016  
white



RAL 7005  
grey

*Ask for more colors!*





## DISPLAY BOX

DISPLAY BOX is a screen holder specially designed for the POD meeting rooms. This screen holder is not only stylish but also makes it possible to hide the disruptive cables and remote control.

### TECHNICAL INFORMATION

Three electrical sockets.  
TV screen and the wall mount brackets are not included.

### MATERIAL DESCRIPTION

MDF board with water-based paint.

### MEASUREMENTS

Up to 42" screen: W700 x D100 x H1400 mm

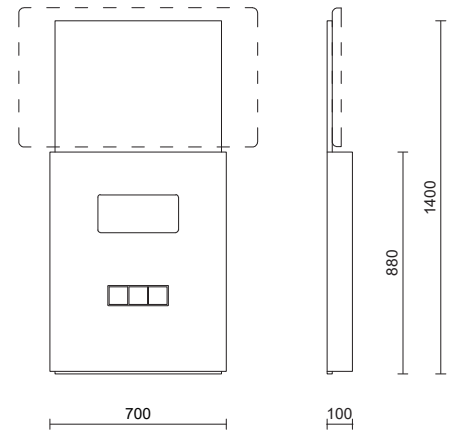

### SURFACE FINISHES FOR DISPLAY BOX:

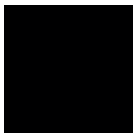

NCS S 9000-N  
Structural



All our materials comply with M1 emission classification.



## CUBE

CUBE is a sheltered sofa that is recommended to place two facing each other, in which case the sofas form an acoustically pleasant environment.



### MATERIAL DESCRIPTION

Frame is fully upholstered with fabric.  
Seat and backrest upholstered polyurethane foam.  
Powder-coated steel tube base.

### OPTIONS

An optional armrest with electrical socket is available.

### MEASUREMENTS

W1600 x D720 x H1600 mm

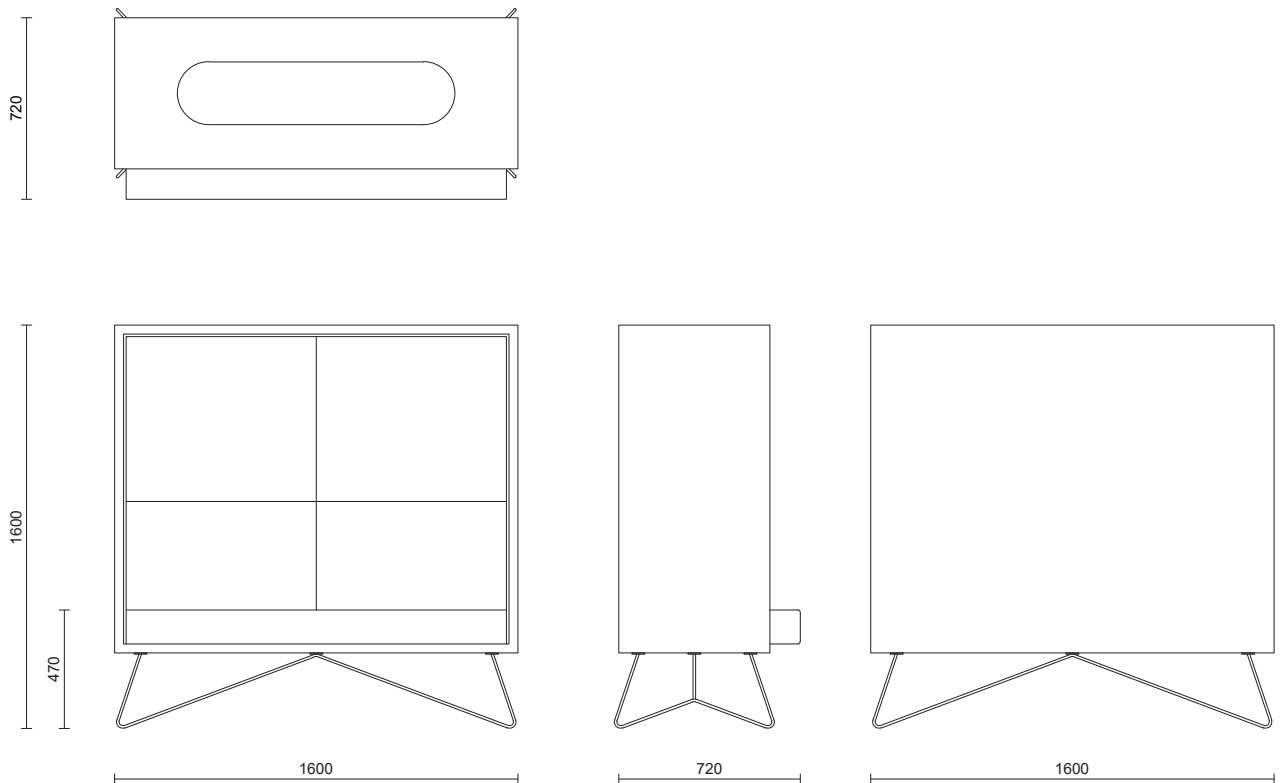



All our materials comply with M1 emission classification.

**CUBE ARMREST**

**TECHNICAL INFORMATION**

Built-in electrical socket.  
The length of the electric cord is 3 m.

**MATERIAL DESCRIPTION**

Veneer structure.  
Upholstered with fabric.

**MEASUREMENTS**

W155 x D340 x H260 mm

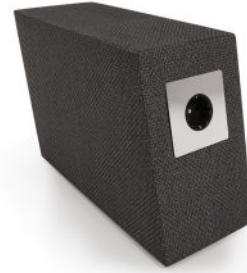

**SOFA FABRIC FOR CUBE: WOOLY FROM NEVOTEX | STANDARD PRICE, CATEGORY 1**

Composition: 70% Recycled wool, 25% Polyamide, 5% Other fibers  
 Durability: 150 000 Martindale  
 Lightfastness: 6  
 Crocking: 4-5/wet, 5/dry  
 Sustainability: certified according to Global Recycled Standard (GRS), no. CU1049784GRS-2023-00050154  
 Cleaning: vacuuming and dry cleaning  
 Fire resistant: Yes



2256 Ivory melange    2301 Marsala    1011 Bottle Green    228881 Lapis    1000 Light grey    2279 Ocean    1001 Anthracite



**SOFA FABRIC FOR CUBE: MAIN LINE FLAX FROM CAMIRA | STANDARD PRICE, CATEGORY 1**

Composition: 70% Virgin wool, 30% Flax  
 Durability: 50.000 Martindale  
 Lightfastness: 5  
 Crocking: 3/wet, 4/dry  
 Sustainability: Complies with EU ecolabel "The Flower", Compostable  
 Cleaning: Vacuuming and dry cleaning  
 Fire resistant: Yes

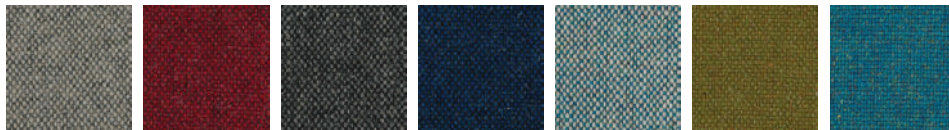

MLF02    MLF14    MLF16    MLF19    MLF24    MLF67    MLF37



**SOFA FABRIC FOR CUBE: PYTON FROM DELFOS FR | PRICE CATEGORY 2**

Synthetic leather  
 Composition: 77% PVC, 23% CO  
 Abrasion / Martindale: dry = 51.200 /cycles, wet = 12.800 /cycles  
 Lightfastness: 5  
 Crocking: 4-5  
 Breathable  
 Fire resistant: Yes / Flame retardant, IMO Certificate

*Cleaning:*  
 Because of its characteristics, clean and care the material frequently, with lukewarm water and a damp cloth, preferably of micro fibre. Soiling may be treated with a mild soap and proceed next to its drying by using a hairdryer or, failing that, a drycloth. It should be avoided that areas that have been treated for cleaning remain wet

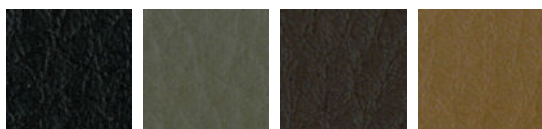

0796 Negro    1112 Smoke    0793 Mocca    1168 Cashmere



## SOFA FABRIC FOR CUBE: GRAIN/2288 FROM GABRIEL | PRICE CATEGORY 2

Composition: 80% post-consumer recycled polyester / 20% polyester

Durability: 100.000 Martindale

Pilling: 5

Light fastness: 5-7

Cleaning: wash or dry cleaning

Fire resistant: Yes



61247

62123

64251

66233

68258

60323

OEKO-TEX®  
CONFIDENCE IN TEXTILES  
STANDARD 100



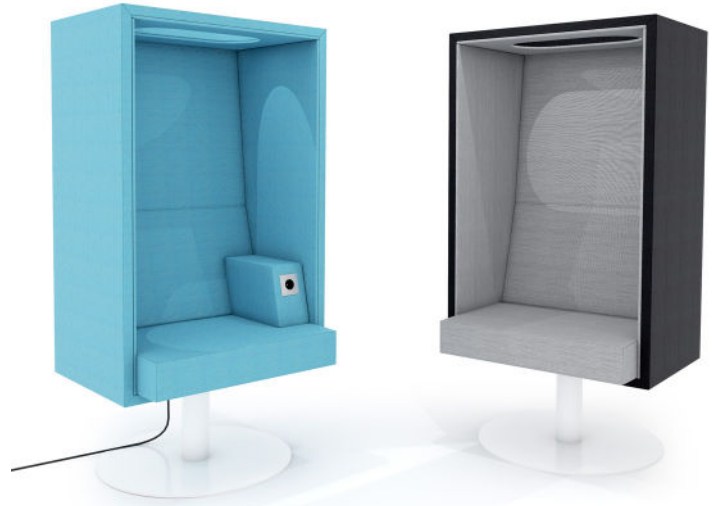

## CUBE SOLO

CUBE SOLO is a rotating swivel chair that provides privacy within an acoustically friendly and comfortable environment. Adding a TOP table turns the chair to a peaceful working area.

### MATERIAL DESCRIPTION

Upholstered with fabric.  
Seat and backrest upholstered polyurethane foam.  
Powder-coated steel tube base.

### OPTIONS

An optional armrest with electrical socket is available.

### MEASUREMENTS

W800 x D720 x H1600 mm

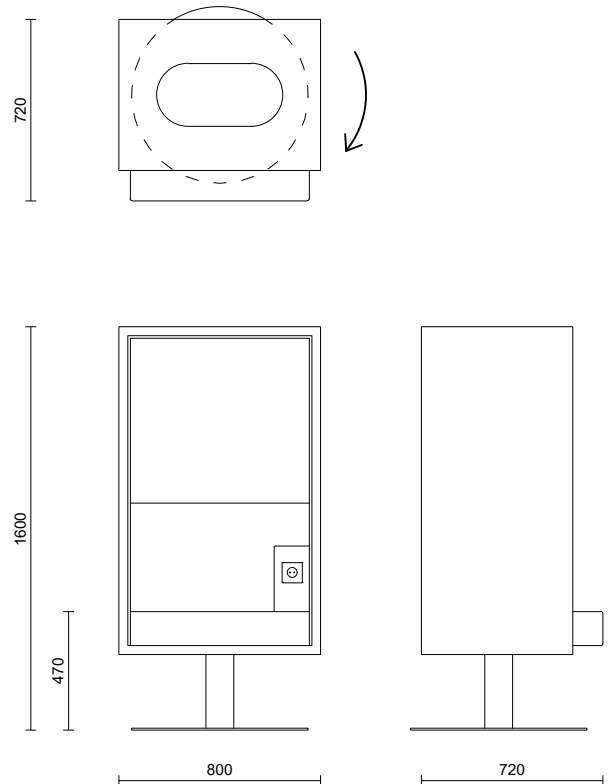



All our materials comply with M1 emission classification.

**CUBE SOLO ARMREST**

**TECHNICAL INFORMATION**

Built-in electrical socket.  
The length of the electric cord is 3 m.

**MATERIAL DESCRIPTION**

Veneer structure.  
Upholstered with fabric.

**MEASUREMENTS**

W155 x D340 x H260 mm

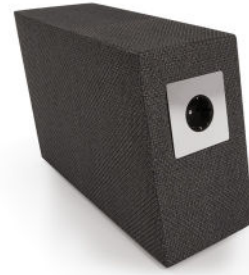

**SOFA FABRIC FOR CUBE SOLO: WOOLY FROM NEVOTEX | STANDARD PRICE, CATEGORY 1**

Composition: 70% Recycled wool, 25% Polyamide, 5% Other fibers  
Durability: 150 000 Martindale  
Lightfastness: 6  
Crocking: 4-5/wet, 5/dry  
Sustainability: certified according to Global Recycled Standard (GRS), no. CU1049784GRS-2023-00050154  
Cleaning: vacuuming and dry cleaning  
Fire resistant: Yes



**SOFA FABRIC FOR CUBE SOLO: MAIN LINE FLAX FROM CAMIRA | STANDARD PRICE, CATEGORY 1**

Composition: 70% Virgin wool, 30% Flax  
Durability: 50.000 Martindale  
Lightfastness: 5  
Crocking: 3/wet, 4/dry  
Sustainability: Complies with EU ecolabel "The Flower", Compostable  
Cleaning: Vacuuming and dry cleaning  
Fire resistant: Yes

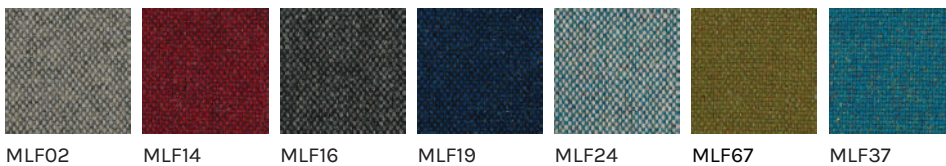

**SOFA FABRIC FOR CUBE SOLO: PYTON FROM DELFOS FR | CATEGORY 2**

Synthetic leather  
Composition: 77% PVC, 23% CO  
Abrasion / Martindale: dry = 51.200 /cycles, wet = 12.800 /cycles  
Lightfastness: 5  
Crocking: 4-5  
Breathable  
Fire resistant: Yes / Flame retardant, IMO Certificate

*Cleaning:*  
Because of its characteristics, clean and care the material frequently, with lukewarm water and a damp cloth, preferably of micro fibre. Soiling may be treated with a mild soap and proceed next to its drying by using a hairdryer or, failing that, a drycloth. It should be avoided that areas that have been treated for cleaning remain wet



# INTO

the Nordic Silence

## SOFA FABRIC FOR CUBE SOLO: GRAIN/2288 FROM GABRIEL | PRICE CATEGORY 2

Composition: 80% post-consumer recycled polyester / 20% polyester

Durability: 100.000 Martindale

Pilling: 5

Light fastness: 5-7

Cleaning: wash or dry cleaning

Fire resistant: Yes



61247

62123

64251

66233

68258

60323

OEKO-TEX®  
CONFIDENCE IN TEXTILES  
STANDARD 100



Ask for more colors: [sales@intoconcept.com](mailto:sales@intoconcept.com)



## POINT SOFAS

POINT office sofa consists of individual sofa modules made of durable and comfortable materials that can be combined to create countless sofa combinations.

### TECHNICAL INFORMATION

The office sofa modules are available with both low and high backrests and the seating measurements support healthy working positions. Connectors included.

### MATERIAL DESCRIPTION

Plywood base and frame.  
Polyurethane foam.  
Fabric upholstery.  
Base color painted grey.

### OPTIONS

Integrated electrical sockets with the power cord length 5 m.  
POINT sofas are available with lockable wheels.

### MEASUREMENTS

POINT:	W500/700/1000 x D700 x H920/1420 mm
POINT STOOL:	W500/700 x D700 x H470 mm
POINT CORNER:	W700 x D700 x H920/1420 mm
POINT CURVE IN:	W1020 x D700 x H920/1420 mm
POINT CURVE OUT:	W1020 x D700 x H920/1420 mm
POINT OUTER CORNER, Left/Right:	W1100 x D700 x H920/1420 mm
Seat height:	470 mm
Seat height with wheels:	480 mm

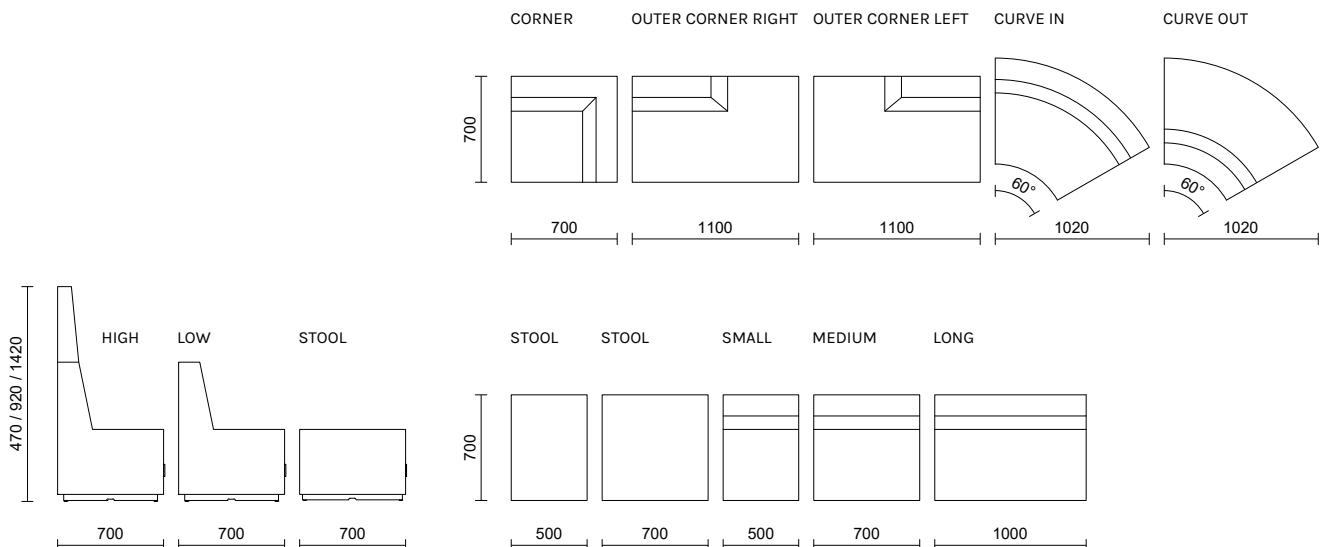





**POINT SOFAS - COMBINING EXAMPLES**

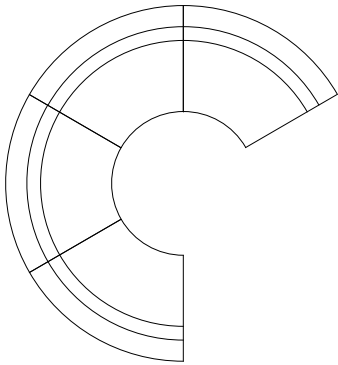

CURVE IN x 4

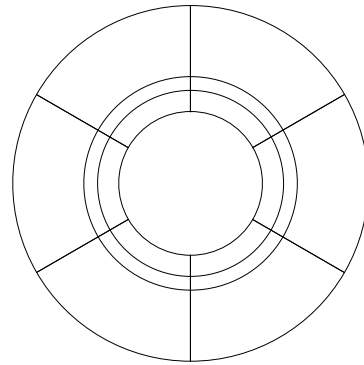

CURVE OUT x 6

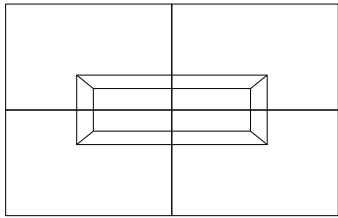

OUTER CORNER x 4

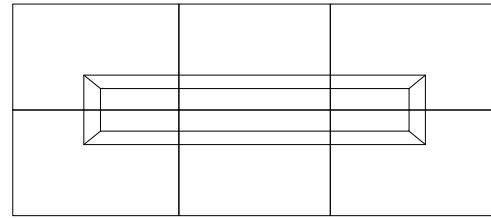

OUTER CORNER x 4  
LONG x 2

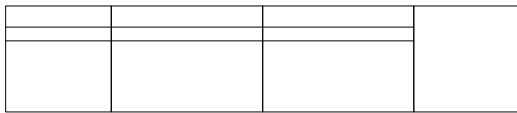

MEDIUM x 1  
LONG x 2  
STOOL x 1

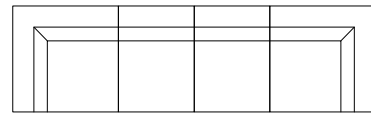

CORNER x 2  
SMALL x 2

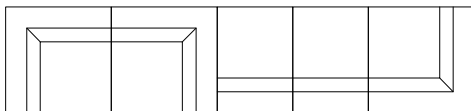

CORNER x 3  
SMALL x 2

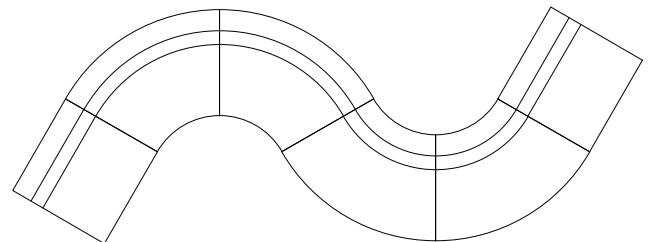

CURVE IN x 2  
CURVE OUT x 2  
MEDIUM x 2



All our materials comply with M1 emission classification.

**UPHOLSTERY FABRIC: WOOLY FROM NEVOTEX | STANDARD PRICE, CATEGORY 1**

Composition: 70% Recycled wool, 25% Polyamide, 5% Other fibers  
 Durability: 150 000 Martindale  
 Lightfastness: 6  
 Crocking: 4-5/wet, 5/dry  
 Sustainability: certified according to Global Recycled Standard (GRS), no. CU1049784GRS-2023-00050154  
 Cleaning: vacuuming and dry cleaning  
 Fire resistant: Yes



**UPHOLSTERY FABRIC: MAIN LINE FLAX FROM CAMIRA | STANDARD PRICE, CATEGORY 1**

Composition: 70% Virgin wool, 30% Flax  
 Durability: 50.000 Martindale  
 Lightfastness: 5  
 Crocking: 3/wet, 4/dry  
 Sustainability: Complies with EU ecolabel "The Flower", Compostable  
 Cleaning: Vacuuming and dry cleaning  
 Fire resistant: Yes

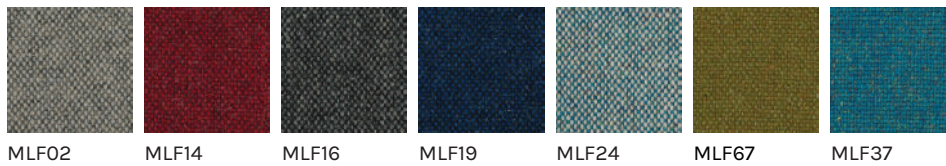

**UPHOLSTERY FABRIC: PYTON FROM DELFOS FR | CATEGORY 2**

Synthetic leather  
 Composition: 77% PVC, 23% CO  
 Abrasion / Martindale: dry = 51.200 /cycles, wet = 12.800 /cycles  
 Lightfastness: 5  
 Crocking: 4-5  
 Breathable  
 Fire resistant: Yes / Flame retardant, IMO Certificate

*Cleaning:*  
 Because of its characteristics, clean and care the material frequently, with lukewarm water and a damp cloth, preferably of micro fibre. Soiling may be treated with a mild soap and proceed next to its drying by using a hairdryer or, failing that, a drycloth. It should be avoided that areas that have been treated for cleaning remain wet



**UPHOLSTERY FABRIC: GRAIN/2288 FROM GABRIEL | PRICE CATEGORY 2**

Composition: 80% post-consumer recycled polyester / 20% polyester  
 Durability: 100.000 Martindale  
 Pilling: 5  
 Light fastness: 5-7  
 Cleaning: wash or dry cleaning  
 Fire resistant: Yes

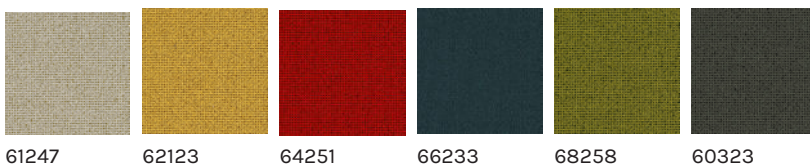

## POINT CUP

POINT CUP office booth is a sound-friendly 360-degree furniture solution that offers a comfortable space for presentations and video conferences.



### TECHNICAL INFORMATION

**SOCKETS** One electrical socket on the table + 3 sockets in the screen wall.

**SCREEN** Screen wall is suitable for 20-42" screen.  
Screen wall does not include screen nor bracket for it.

**ELECTRICITY CONNECTION** The length of the electric cord for the POINT CUP solution is 3 m.

**MATERIAL DESCRIPTION** Office booth sofa modules with plywood frame, polyurethane foam and fabric upholstery.  
Table with structural paint top and powder-coated steel base.  
Base board painted MDF.  
Screen wall painted MDF and felt from the back.

**OPTIONS** Tabletop with laminate.

**MEASUREMENTS** W2450 x D2350 x H1420 mm  
TOP CUP table Ø900 / H720 mm

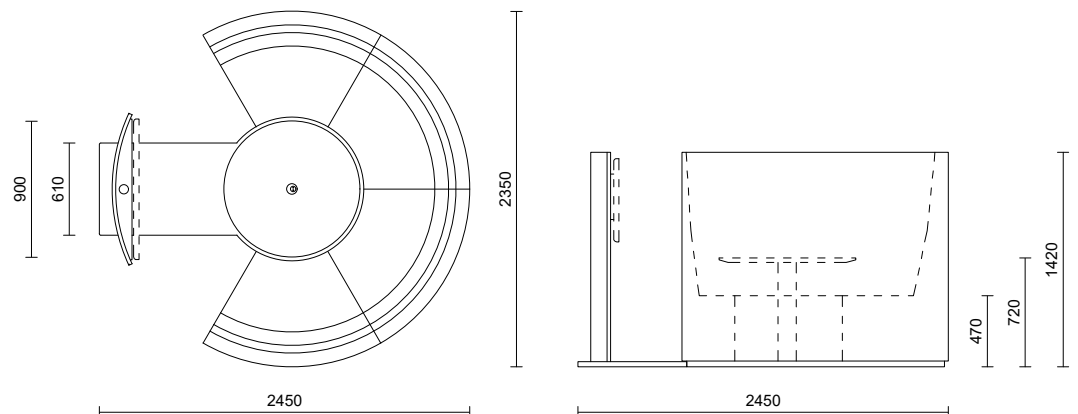



All our materials comply with M1 emission classification.

**UPHOLSTERY FABRIC FOR POINT CUP: WOOLY FROM NEVOTEX | STANDARD PRICE, CATEGORY 1**

Composition: 70% Recycled wool, 25% Polyamide, 5% Other fibers  
 Durability: 150 000 Martindale  
 Lightfastness: 6  
 Crocking: 4-5/wet, 5/dry  
 Sustainability: certified according to Global Recycled Standard (GRS), no. CU1049784GRS-2023-00050154  
 Cleaning: vacuuming and dry cleaning  
 Fire resistant: Yes



2256 Ivory melange    2301 Marsala    1011 Bottle Green    228881 Lapis    1000 Light grey    2279 Ocean    1001 Anthracite



**UPHOLSTERY FABRIC FOR POINT CUP: MAIN LINE FLAX FROM CAMIRA | STANDARD PRICE, CATEGORY 1**

Composition: 70% Virgin wool, 30% Flax  
 Durability: 50.000 Martindale  
 Lightfastness: 5  
 Crocking: 3/wet, 4/dry  
 Sustainability: Complies with EU ecolabel "The Flower", Compostable  
 Cleaning: Vacuuming and dry cleaning  
 Fire resistant: Yes

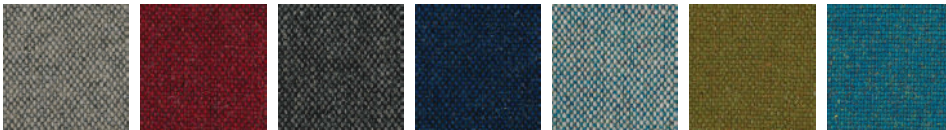

MLF02    MLF14    MLF16    MLF19    MLF24    MLF67    MLF37



**UPHOLSTERY FABRIC FOR POINT CUP: PYTON FROM DELFOS FR | CATEGORY 2**

Synthetic leather  
 Composition: 77% PVC, 23% CO  
 Abrasion / Martindale: dry = 51.200 /cycles, wet = 12.800 /cycles  
 Lightfastness: 5  
 Crocking: 4-5  
 Breathable  
 Fire resistant: Yes / Flame retardant, IMO Certificate

*Cleaning:*  
 Because of its characteristics, clean and care the material frequently, with lukewarm water and a damp cloth, preferably of micro fibre. Soiling may be treated with a mild soap and proceed next to its drying by using a hairdryer or, failing that, a drycloth. It should be avoided that areas that have been treated for cleaning remain wet



0796 Negro    1112 Smoke    0793 Mocca    1168 Cashmere



**UPHOLSTERY FABRIC FOR POINT CUP: GRAIN/2288 FROM GABRIEL | PRICE CATEGORY 2**

Composition: 80% post-consumer recycled polyester / 20% polyester  
 Durability: 100.000 Martindale  
 Pilling: 5  
 Light fastness: 5-7  
 Cleaning: wash or dry cleaning  
 Fire resistant: Yes

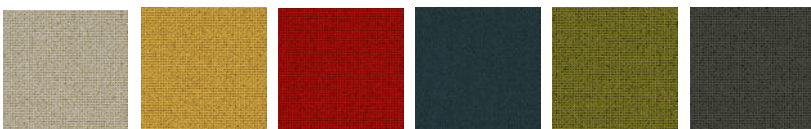

61247    62123    64251    66233    68258    60323



**COLOR OPTIONS FOR POINT CUP TABLE**

**STANDARD PRICE, CATEGORY 1**



NCS S 0500-N  
Structural

**PRICE CATEGORY 2**

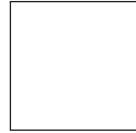

White  
lamine

**STEEL TUBE BASE | STANDARD PRICE, CATEGORY 1**

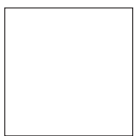

RAL 9016

**FELT FOR CUP SCREEN HOLDER: FULDA FIT FROM FILZFABRIK | STANDARD PRICE, CATEGORY 1**

Composition: 30% Polyamid, 70% Polypropylen  
Static electrical propensity: Antistatic  
Classification for use: Commercial / heavy use  
Fire resistant: Yes

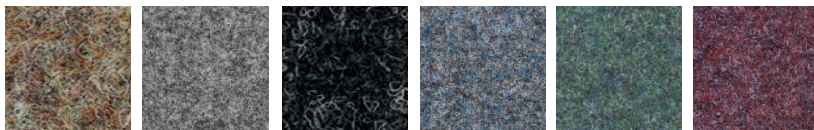

37

61

69

52

85

16

**SCREEN WALL COLOR | STANDARD PRICE, CATEGORY 1**

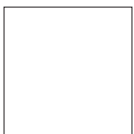

NCS S 0500-N  
Smooth

**BASEBOARD COLOR | STANDARD PRICE, CATEGORY 1**

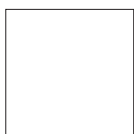

NCS S 0500-N  
Structural



## TOP TABLES

TOP TABLES are visually slender yet structurally steady table solutions that enable ergonomic and flexible work. Table sizes go from small laptop tables up to bigger working desks.

### TECHNICAL INFORMATION

Available with either fixed leg or height-adjustable leg.  
Height is adjusted with a gas spring from a handle installed on the edge of the table top.

### MATERIAL DESCRIPTION

MDF table top painted with structural paint.  
Base powder coated steel.

### MIX AND MATCH

Choose the tabletop and leg that suits your needs.

### OPTIONS

Table top with laminate.

### TESTED

INTO TOP tables are tested and approved according with standard EN 15372:2016 which is European furniture standard testing strength, durability, and safety.

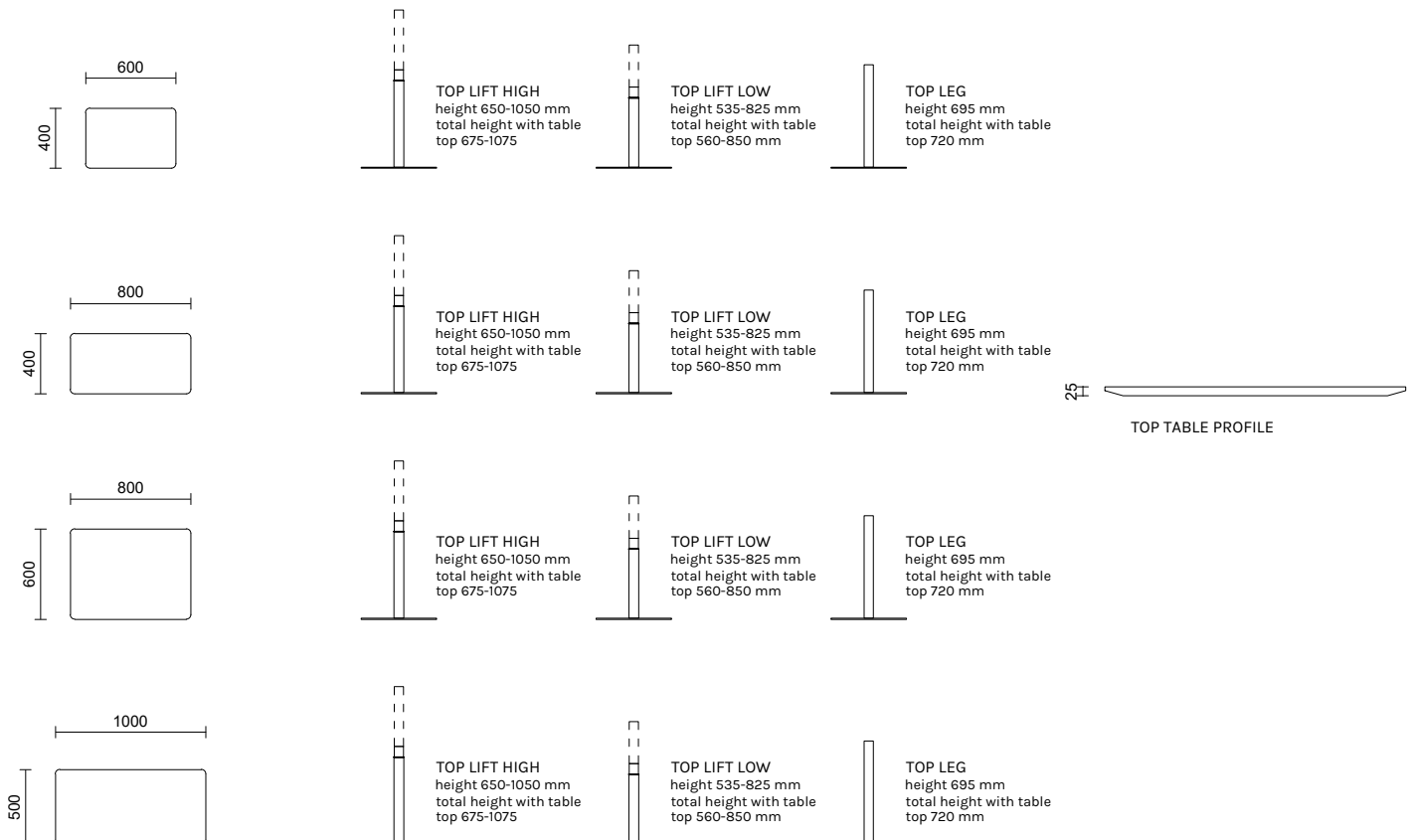



## TOP TABLES

TOP TABLES are visually slender yet structurally steady table solutions that enable ergonomic and flexible work. Table sizes go from small laptop tables up to bigger working desks.

### TECHNICAL INFORMATION

Available with either fixed leg or height-adjustable leg.  
Height is adjusted with a gas spring from a handle installed on the edge of the table top.

### MATERIAL DESCRIPTION

MDF table top painted with structural paint.  
Base powder coated steel.

### MIX AND MATCH

Choose the tabletop and leg that suits your needs.

### OPTIONS

Table top with laminate.

### TESTED

INTO TOP tables are tested and approved according with standard EN 15372:2016 which is European furniture standard testing strength, durability, and safety.

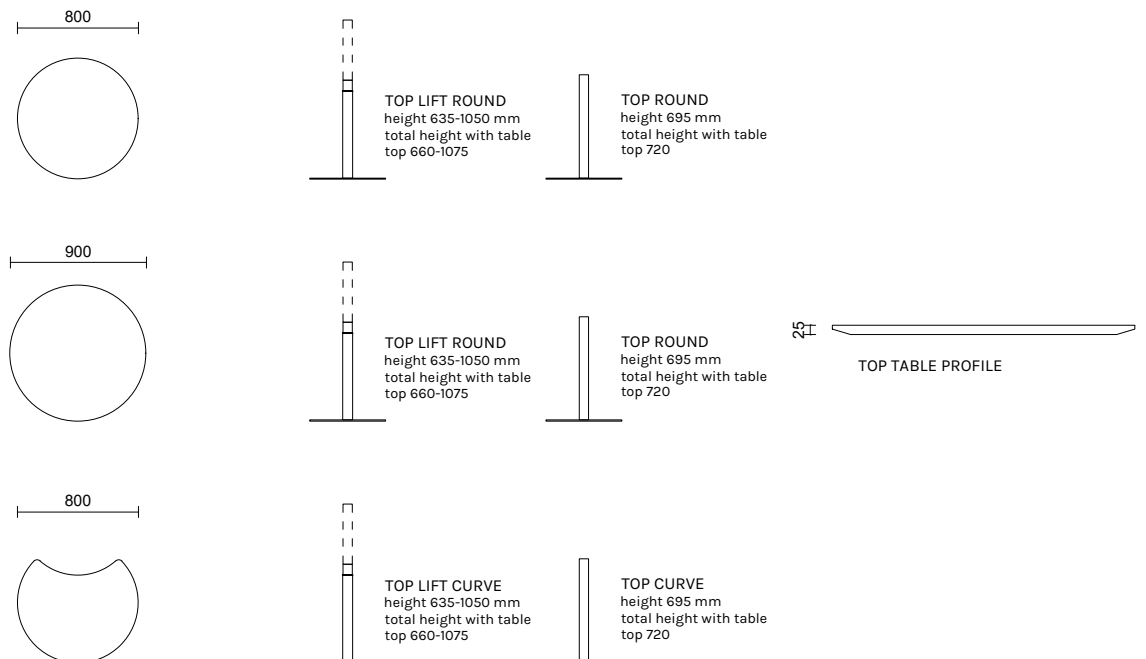

## COLOR OPTIONS FOR TOP AND TOP LIFT TABLES

### STANDARD PRICE, CATEGORY 1

Standard paint color options

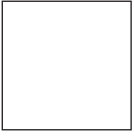

NCS S 0500-N  
Structural

### PRICE CATEGORY 2



White  
laminate



Black  
laminate

### PRICE CATEGORY 3



Black nano-  
laminate

### POWDER COATED STEEL TUBE BASE | STANDARD PRICE, CATEGORY 1

Standard base paint options

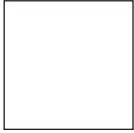

RAL 9016

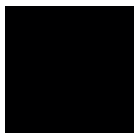

RAL 9005





## FOCUS

FOCUS is private workstation on wheels, and it provides both visual haven and true peace of mind while working. This acoustic desk is upholstered in felt that not only looks good but also creates an acoustically friendly environment.



### TECHNICAL INFORMATION

Wheels included.  
Table light with switch.  
2 x electrical socket.  
The electric cord length for the FOCUS solution is 3 m.

### MATERIAL DESCRIPTION

Bent board frame.  
Felt upholstered inside and outside.  
Fixed table painted with structural paint.

### MEASUREMENTS

W1530 x D1400 x H1570 mm

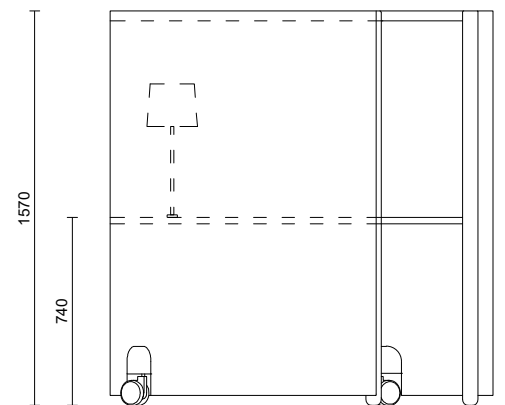
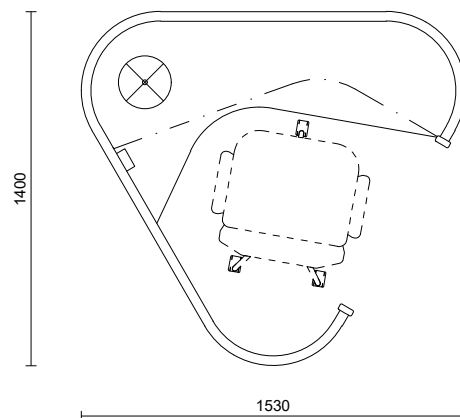



All our materials comply with M1 emission classification.

## FELT FOR FOCUS: FULDA FIT FROM FILZFABRIK | STANDARD PRICE, CATEGORY 1

Composition: 30% Polyamid, 70% Polypropylen  
Static electrical propensity: Antistatic  
Classification for use: Commercial / heavy use  
Fire resistant: Yes

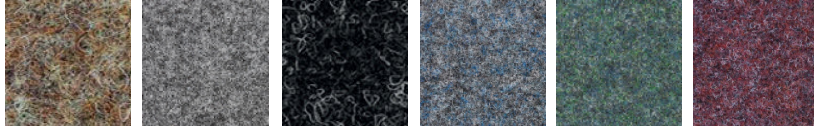

37

61

69

52

85

16

## COLOR OPTION FOR THE TABLE | STANDARD PRICE, CATEGORY 1



NCS S 0500-N  
Structural

## ROLL IN

ROLL IN is a workstation with wheels that offers a handy haven for those who need to focus in private during their workday. This workstation with wheels includes fixed lighting, a built-in electrical socket as well as two bag hooks under the table.



### TECHNICAL INFORMATION

Lockable wheels included.  
2 x built-in electrical socket.  
2 x bag hooks under the table.  
Light with switch.  
The electric cord length for the ROLL IN solution is 3 m.

### MATERIAL DESCRIPTION

MDF frame with tabletop painted with white structural paint or optionally veneer frame with veneer tabletop.  
Base powder-coated steel.  
Acrylic window.

### MEASUREMENTS

W1190 x D680 x H1510 mm

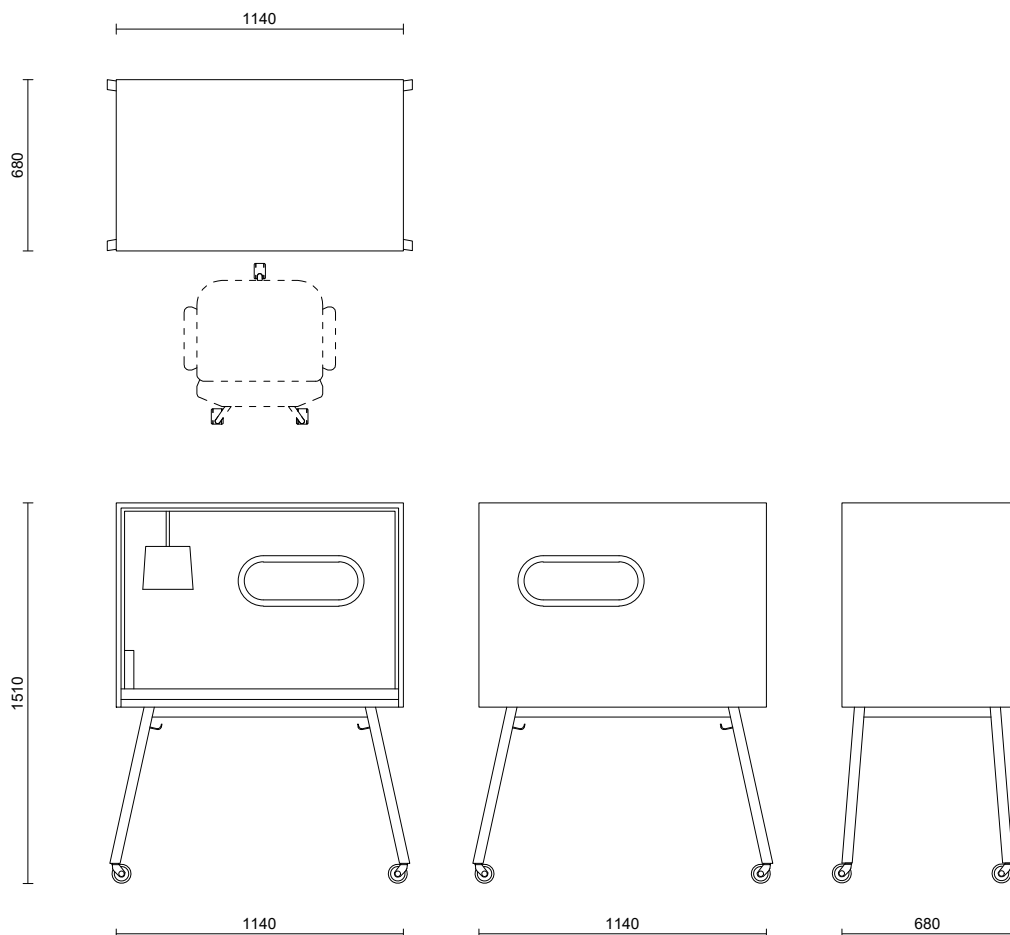



All our materials comply with M1 emission classification.

**SURFACE FINISHES FOR ROLL IN:**

STANDARD PRICE, CATEGORY 1



NCS S 0500-N  
Smooth

PRICE CATEGORY 2



Pine veneer

PRICE CATEGORY 3

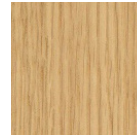

Oak veneer



The mark of responsible forestry

**INSIDE PANEL FABRIC: SOUL FROM GABRIEL | STANDARD PRICE, CATEGORY 1**

Composition: 100% wool

Lightfastness: 5-7

Rubbing fastness: 4/wet, 4-5/dry

Sustainability: Complies with STANDARD 100 by OEKO-TEX

Meet Möbelfakta requirements

Cleaning: regular vacuum cleaning

Fire resistant: Yes (S 476 Part 7, class 1 ÖNORM B 3825-B1-3800-Q1 UK)

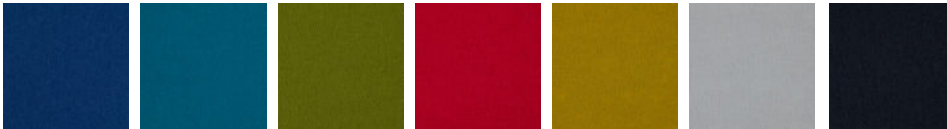

66104

67039

68131

64086

62059

61196

60182



**STEEL TUBE BASE | STANDARD PRICE, CATEGORY 1**

Standard base paint options

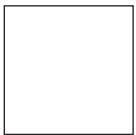

RAL 9016



RAL 9005

## STORY WALL

STORY WALL is a multipurpose space divider on wheels. It absorbs sound waves creating pleasant sound environment, is easy to move around the premises, and adapts to customer's needs with its various add-on pieces.



### TECHNICAL INFORMATION

Includes wheels and adjustable support legs.

### MATERIAL DESCRIPTION

Plywood + chipboard frame filled with acoustical wool. Both sides upholstered with felt.

### OPTIONS TO ADD

TV bracket	Magazine holder
Corner piece	Small shelf
Whiteboard	Big shelf
Marker tray	Small coat hanger
Basketball hoop	Big coat hanger
Basketball holder	Cupholder
Dartboard	

### MEASUREMENTS

W1190 x D600 x H2100 mm

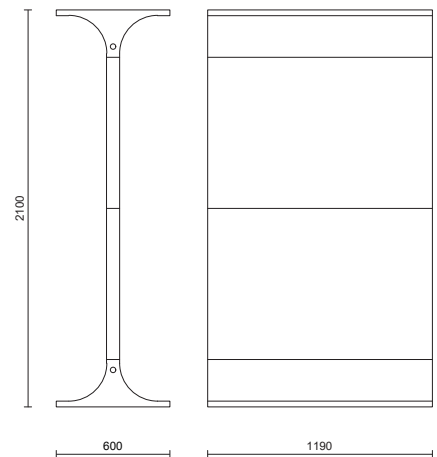

### FELT FOR STORY WALL: FULDA FIT FROM FILZFABRIK | STANDARD PRICE, CATEGORY 1

Composition: 30% Polyamid, 70% Polypropylen  
 Static electrical propensity: Antistatic  
 Classification for use: Commercial / heavy use  
 Fire resistant: Yes

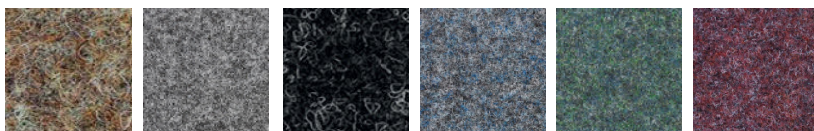

37

61

69

52

85

16



All our materials comply with M1 emission classification.

## CORNER PIECE FOR STORY WALL

Corner piece for the STORY WALL can be used to create corners and therefore, for example, rooms and nooks for teamwork and brainstorming.

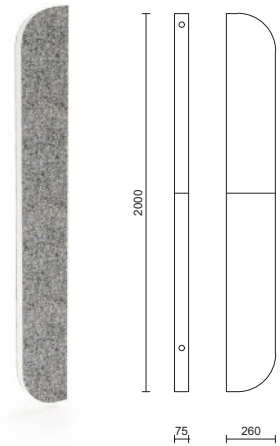

### TECHNICAL INFORMATION

Includes strong magnets for attaching to the STORY WALL.

### MATERIAL DESCRIPTION

Chipboard frame.  
Both sides upholstered with felt.

### MEASUREMENTS

W260 x D75 x H2000 mm

Option for a corner piece for higher STORY WALL available, contact our team.

### EXAMPLES OF HOW TO USE



### FELT FOR STORY WALL CORNER: FULDA FIT FROM FILZFABRIK | STANDARD PRICE, CATEGORY 1

Composition: 30% Polyamid, 70% Polypropylen  
Static electrical propensity: Antistatic  
Classification for use: Commercial / heavy use  
Fire resistant: Yes

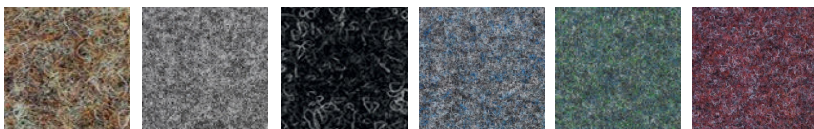

37

61

69

52

85

16

INTO Concept Ltd reserves a right to make changes to product portfolio as well as moderate, enhancing changes to the products.



All our materials comply with M1 emission classification.

## STORY WALL HIGH

STORY WALL HIGH is an acoustical space divider with felt. The space divider adapts to whichever room you are in. The adjacent wall units can be easily connected to each other via integrated fittings. Moreover, the STORY WALL space divider can be conveniently moved and rotated around because of its own built-in wheels.

**TECHNICAL INFORMATION** Includes wheels and adjustable support legs.

**MATERIAL DESCRIPTION** Plywood + chipboard frame filled with acoustical wool. Both sides upholstered with felt.

**OPTIONS TO ADD**

TV bracket	Magazine holder
Corner piece	Small shelf
Whiteboard	Big shelf
Marker tray	Small coat hanger
Basketball hoop	Big coat hanger
Basketball holder	Cup holder
Dartboard	

**MEASUREMENTS** W 1190 x D600 x H2900 mm  
Minimum order quantity 2 pieces

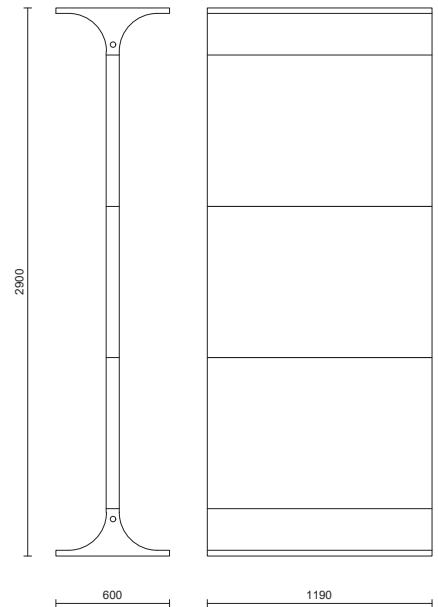

### FELT FOR STORY WALL HIGH: FULDA FIT FROM FILZFABRIK | STANDARD PRICE, CATEGORY 1

Composition: 30% Polyamid, 70% Polypropylen  
Static electrical propensity: Antistatic  
Classification for use: Commercial / heavy use  
Fire resistant: Yes

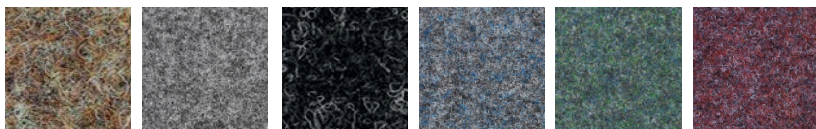

37

61

69

52

85

16

INTO Concept Ltd reserves a right to make changes to product portfolio as well as moderate, enhancing changes to the products.



All our materials comply with M1 emission classification.

## STORY WALL LOW

STORY WALL LOW is child-friendly acoustic space divider with felt. It ensures visibility for adults while providing a safe and comfortable way to divide spaces. The units connect easily via integrated fittings, and built-in wheels allow effortless movement and rotation.



**TECHNICAL INFORMATION** Includes wheels and adjustable support legs.

**MATERIAL DESCRIPTION** Plywood + chipboard frame filled with acoustical wool. Both sides upholstered with felt.

**OPTIONS TO ADD**

Whiteboard	Magazine holder
Marker tray	Small shelf
Basketball hoop	Big shelf
Basketball holder	Small coat hanger
Dartboard	Big coat hanger
	Cup holder

**MEASUREMENTS** W 1190 x D600 x H1320 mm

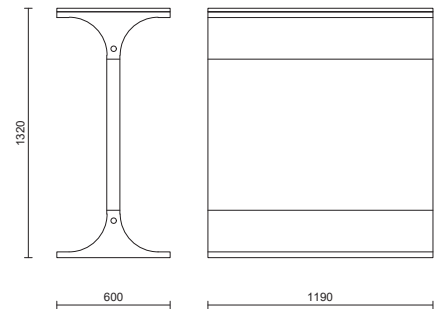

### FELT FOR STORY WALL HIGH: FULDA FIT FROM FILZFABRIK | STANDARD PRICE, CATEGORY 1

Composition: 30% Polyamid, 70% Polypropylen  
 Static electrical propensity: Antistatic  
 Classification for use: Commercial / heavy use  
 Fire resistant: Yes

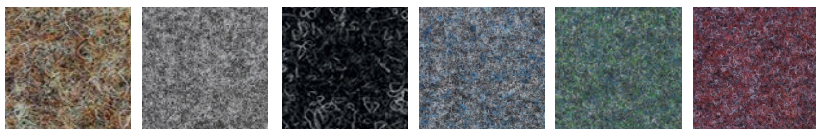

37

61

69

52

85

16

INTO Concept Ltd reserves a right to make changes to product portfolio as well as moderate, enhancing changes to the products.



All our materials comply with M1 emission classification.



## TV BRACKET FOR STORY WALL

Turn your space divider into a stylish screen holder.  
TV Bracket comes with a marker tray that has an extend cord holder.

**TECHNICAL INFORMATION** Holds a screen of maximum "42.

**MATERIAL DESCRIPTION** Steel plate painted white.



## WHITEBOARD FOR STORY WALL

Convert your STORY WALL into an inspiration board with whiteboards. The whiteboard is easy to attach to the STORY WALL with a magnet, and multiple whiteboards can be attached side by side. There is an option for 1-4 whiteboards as add-on pieces.



<b>TECHNICAL INFORMATION</b>	Attaches to the STORY WALL with a magnet.
<b>MATERIAL DESCRIPTION</b>	Painted steel plate painted white. Magnetic surface.
<b>MEASUREMENTS</b>	W1120 x H790 mm

## MARKER TRAY FOR STORY WALL

Make working more efficient with a handy STORY WALL marker tray to place under the whiteboard. The marker tray is easily attached to the STORY WALL with a magnet.



**TECHNICAL INFORMATION**      Attachable with a magnet.

**MATERIAL DESCRIPTION**      Steel plate painted white.

**MEASUREMENTS**                  W1119 x D72 x H101 mm

## MAGAZINE HOLDER FOR STORY WALL

Conveniently place your magazines and brochures on display in the STORY WALL magazine holder. The magazine holder is easily attached to the STORY WALL with a magnet.



**TECHNICAL INFORMATION**      Attachable with a magnet.

**MATERIAL DESCRIPTION**      Steel plate painted white.

**MEASUREMENTS**              W215 x D72 x H305 mm

## DARTBOARD FOR STORY WALL

Take a break from work and play with STORY WALL dartboard. The dartboard is easily attached to the STORY WALL with a magnet and includes five darts.



### TECHNICAL INFORMATION

Attachable with a magnet.  
Dartboard includes one white dartboard and five darts.

### MATERIAL DESCRIPTION

Steel plate painted white.

### MEASUREMENTS

W1120 x H790 mm

## BASKETBALL HOOP FOR STORY WALL

Make your office or school environment more fun with STORY WALL basketball hoop. The basketball hoop is easily attached to the STORY WALL with a magnet.



<b>TECHNICAL INFORMATION</b>	Attachable with a magnet. Basketball hoop comes with one small basketball.
<b>MATERIAL DESCRIPTION</b>	Steel plate painted white.
<b>MEASUREMENTS</b>	W559 x H395 mm

## BASKETBALL HOLDER FOR STORY WALL

Conveniently place your small basketball in the STORY WALL basketball holder. The basketball holder is easily attached to the STORY WALL with a magnet.



**TECHNICAL INFORMATION**      Attachable with a magnet.

**MATERIAL DESCRIPTION**      Steel plate painted white.

**MEASUREMENTS**              W150 x H215 mm

## SHORT SHELF FOR STORY WALL

Place your items and decorations on STORY WALL short shelf. The short shelf is easily attached to the STORY WALL with a magnet.

**TECHNICAL INFORMATION**      Attachable with a magnet.

**MATERIAL DESCRIPTION**      Steel plate painted white.

**MEASUREMENTS**      W560 x H240 mm





## LONG SHELF FOR STORY WALL



You can use STORY WALL long shelf to display your items, plants and decorations. The Long shelf is easily attached to the STORY WALL with a magnet.

**TECHNICAL INFORMATION**      Attachable with a magnet.

**MATERIAL DESCRIPTION**      Steel plate painted white.

**MEASUREMENTS**                  W1118 x H241 mm

## SHORT COAT HANGER FOR STORY WALL



Hang your clothes and bags on STORY WALL short coat hanger. The short coat hanger is easily attached to the STORY WALL with a magnet and has two jacket hooks.

**TECHNICAL INFORMATION**                      Attachable with a magnet. Short coat hanger with two jacket hooks.

**MATERIAL DESCRIPTION**                      Steel plate painted white.

**MEASUREMENTS**                                      W215 x H151 mm

## LONG COAT HANGER FOR STORY WALL

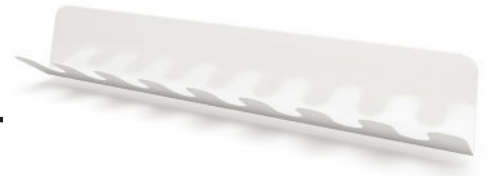

Hang your clothes and bags on STORY WALL long coat hanger. The long coat hanger is easily attached to the STORY WALL with a magnet and has nine jacket hooks.

**TECHNICAL INFORMATION**                      Attachable with a magnet. Long coat hanger has nine jacket hooks.

**MATERIAL DESCRIPTION**                      Steel plate painted white.

**MEASUREMENTS**                                      W1120 x H151 mm

## CUP HOLDER FOR STORY WALL



Free your desk from clutter and place your cups on STORY WALL cup holder. Small cup holder holds two cups and is easily attached to the STORY WALL with a magnet.

**TECHNICAL INFORMATION**      Attachable with a magnet. Small cup holder holds two cups.

**MATERIAL DESCRIPTION**      Steel plate painted white.

**MEASUREMENTS**      W215 x H149 mm. The diameter of the hole is 70 mm.

## WALL PANEL

The wall panels can be easily mounted to existing walls, providing a simple solution to enhance acoustics in any space. In addition to improving sound quality, they add a vibrant touch of color into the environment.

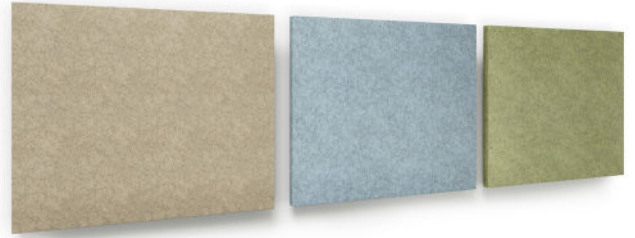

### TECHNICAL INFORMATION

Easy to attach and detach with effortless fastening system.

### MATERIAL DESCRIPTION

Plywood frame with acoustic wool.  
Fully upholstered.

### MEASUREMENTS

W1200 x D45 x H1000 mm

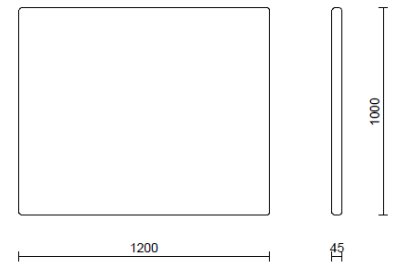

### WALL PANEL FABRIC: SOUL FROM GABRIEL | STANDARD PRICE, CATEGORY 1

Composition: 100% wool

Lightfastness: 5-7

Rubbing fastness: 4/wet, 4-5/dry

Sustainability: Complies with STANDARD 100 by OEKO-TEX

Meet Möbelfakta requirements

Cleaning: regular vacuum cleaning

Fire resistant: Yes (S 476 Part 7, class 1 ÖNORM B 3825-B1-3800-Q1 UK)



All our materials comply with M1 emission classification.



66104

67039

68131

64086

62059

61196

60182

**OEKO-TEX®**  
CONFIDENCE IN TEXTILES  
**STANDARD 100**

